

OBS! Note! Achtung!

Check at du har alle kasser før du starter
Before start please check that you have all boxes
Bitte überprüfen Sie, dass Sie alle Boxen haben

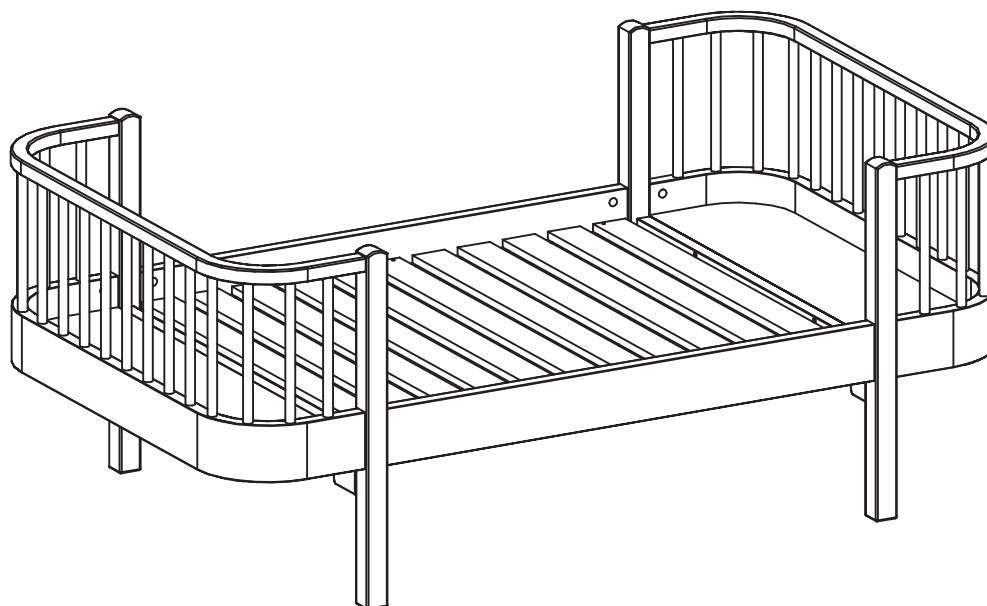

041400 Junior Seng Junior Bed Junior Bett

Colis-Nr. Package-no. Pakke nr.	Anzahl Quantities Antal	Maß,mm Dimensions,mm Størrelse, mm	✓
051405	2	1050 x 490 x 310	
051401	1	1180 x 210 x 140	
051412	1	840 x 160 x 120	
051426	1	960 x 190 x 130	

**Oliver
furniture**

CLASSIC NORDIC

OBS! Note! Achtung!

Check at du har alle kasser før du starter
Before start please check that you have all boxes
Bitte überprüfen Sie, dass Sie alle Boxen haben

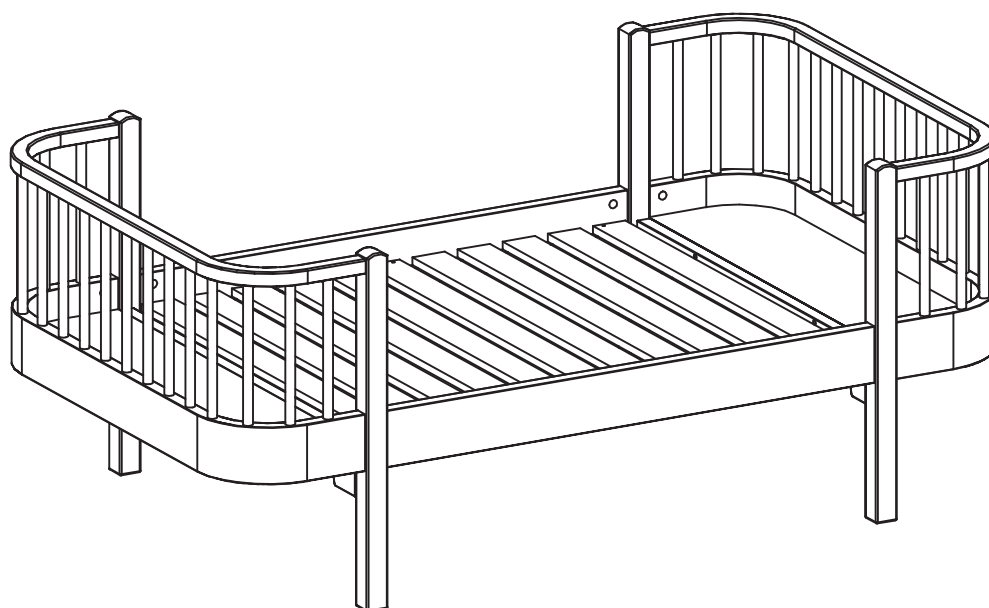

041401 Junior Seng Junior Bed Junior Bett

Colis-Nr. Package-no. Pakke nr.	Anzahl Quantities Antal	Maß,mm Dimensions,mm Størrelse, mm	✓
051405	2	1050 x 490 x 310	
051401	1	1180 x 210 x 140	
051413	1	840 x 160 x 120	
051426	1	960 x 190 x 130	

**Oliver
furniture**

CLASSIC NORDIC

Wood

041400_041401 Seng_Junior
041400_041401 Bed_Junior
041400_041401 Bett_Junior

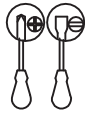
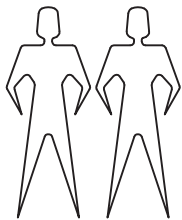





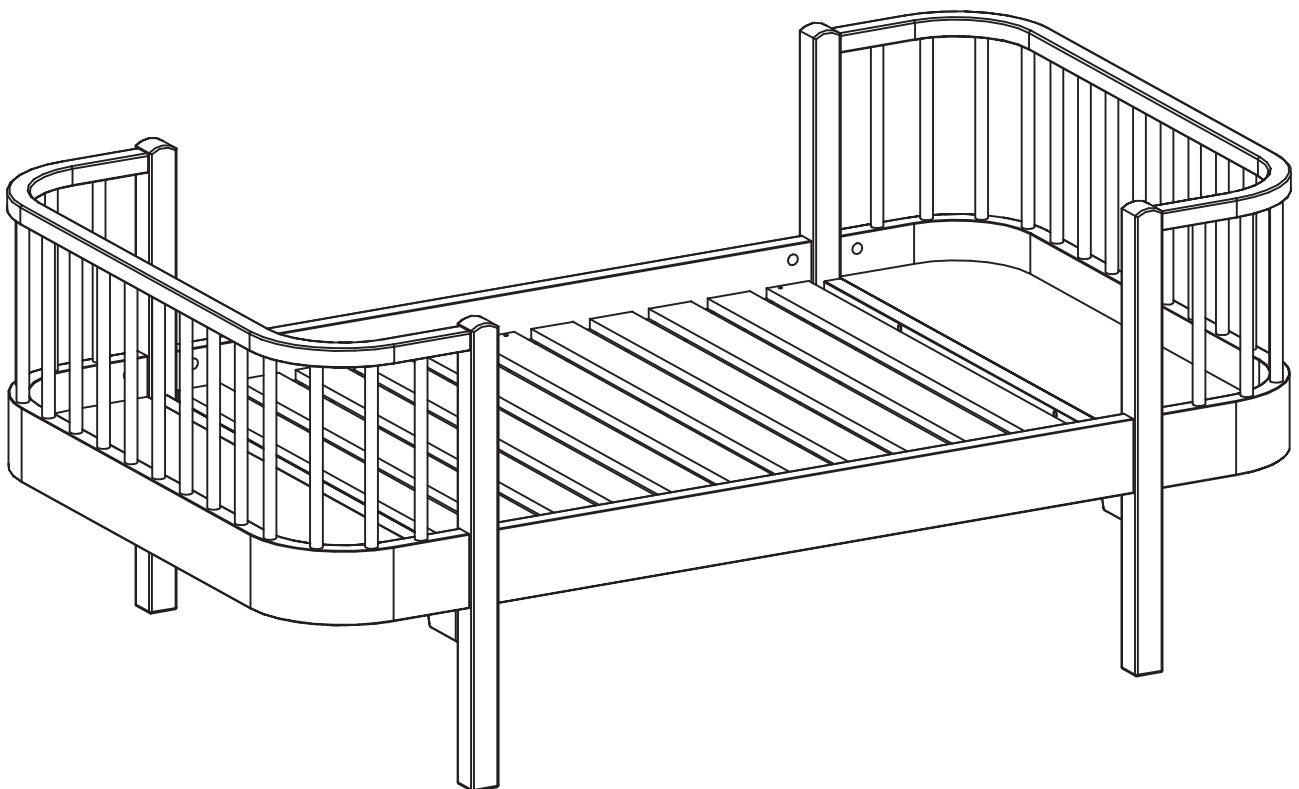

OLIVER FURNITURE A/S
Ndr. Strandvej 119 A
3150 Hellebæk
Denmark

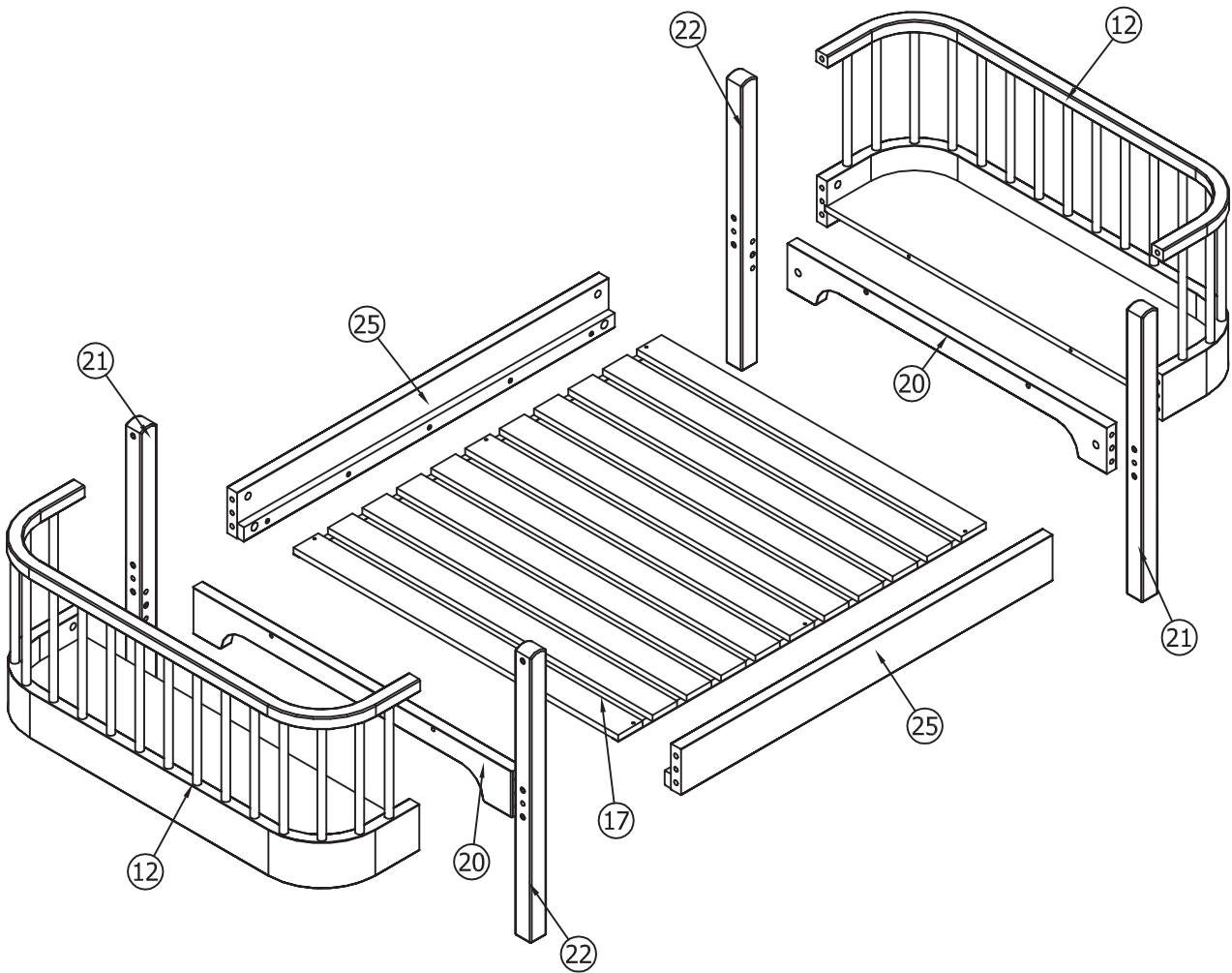
Tel. +45 4970 7317
www.oliverfurniture.dk

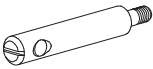

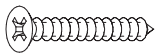
Teil-Nr. Pieces-no. Enheds nr.	Anzahl Quantities Antal	Colis-Nr. Package-no. Pakke nr.	Maß, mm Dimensions, mm Størrelse, mm	✓
12	2	051405	960 x 410 x 272	
17	1	051426	1428 x 898 x 15	
20	2	051403	884 x 110 x 28	
21	2	051412	690 x 44 x 44	
22	2	051412 051413	690 x 44 x 44	
25	2	051401	1028 x 110 x 46	

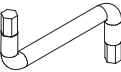
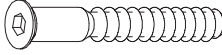

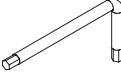
D147		x24 Ø10x46 M6	D150		24 M10 SW4	A66		x6 Ø3,5x25
D149		x24 Ø16x20	A5		x1 4 mm	A27		x4 Ø7x50
H4		x16 Ø10x40	A6		x1 4 mm			

Start på et plant og jævnt underlag. Brug eventuelt pap fra emballagen som underlag. Det er muligt at samle sengen alene, men vi anbefaler at være to personer.

Vær opmærksom på, at når sengen er i løse dele, er den meget udsat for lakskader på hjørner og kanter. Man skal derfor være meget forsigtig, når sengen samles.

It is a good idea to assemble the bed on a smooth and even surface. Use the cardboard from the packaging as underlay. It is possible for one person to assemble the bed however we recommend that you are two persons.

Be aware that the bed is very exposed to lacquer damage on the corners and edges due to all the different parts. Therefore you must be very careful when assembling the bed.

Fangen Sie auf eine ebene und gerade Unterlage an. Die Pappe von der Verpackung können Sie eventuell als Unterlage benutzen.



Es ist möglich das Bett alleine zu montieren, aber wir empfehlen es zu zweit zu machen.

Seien Sie darauf aufmerksam, dass das Bett solange es zerlegt ist, sehr empfindlich gegenüber Lackschäden an Ecken und Kanten ist.

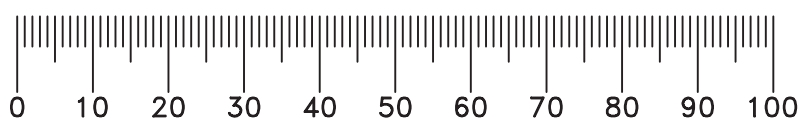

Die Montage soll daher vorsichtig gemacht werden.

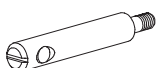
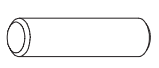
Achten Sie darauf, die gewindeschrauben NICHT ganz festzuspannen ehe das Bett fertig montiert ist.



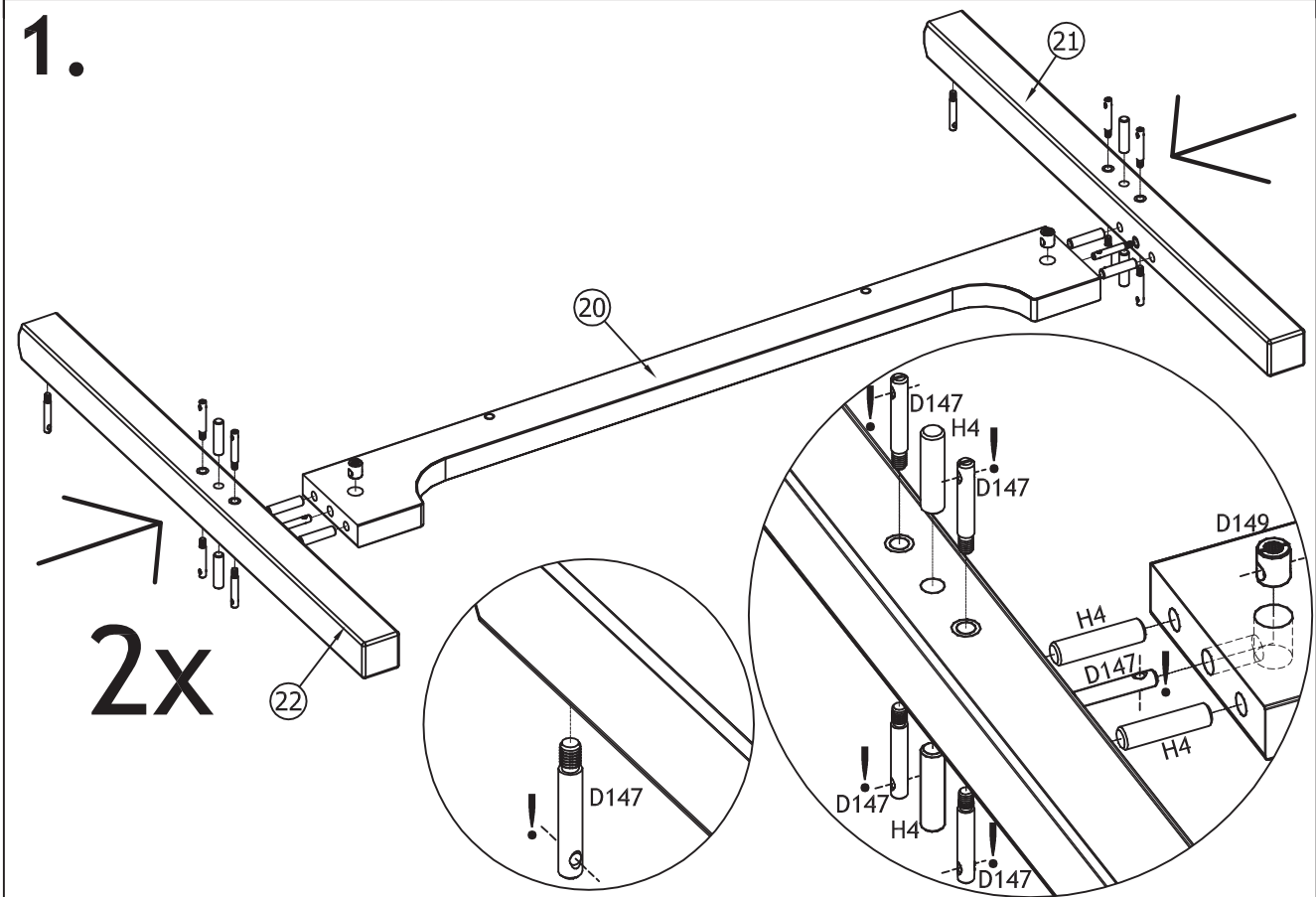

D147		x24 Ø10x46 M6	H4		x16 Ø10x40	D149		x4 Ø16x20
------	---	------------------	----	---	---------------	------	---	--------------

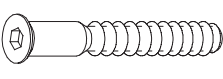
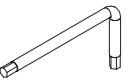
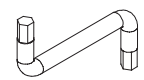

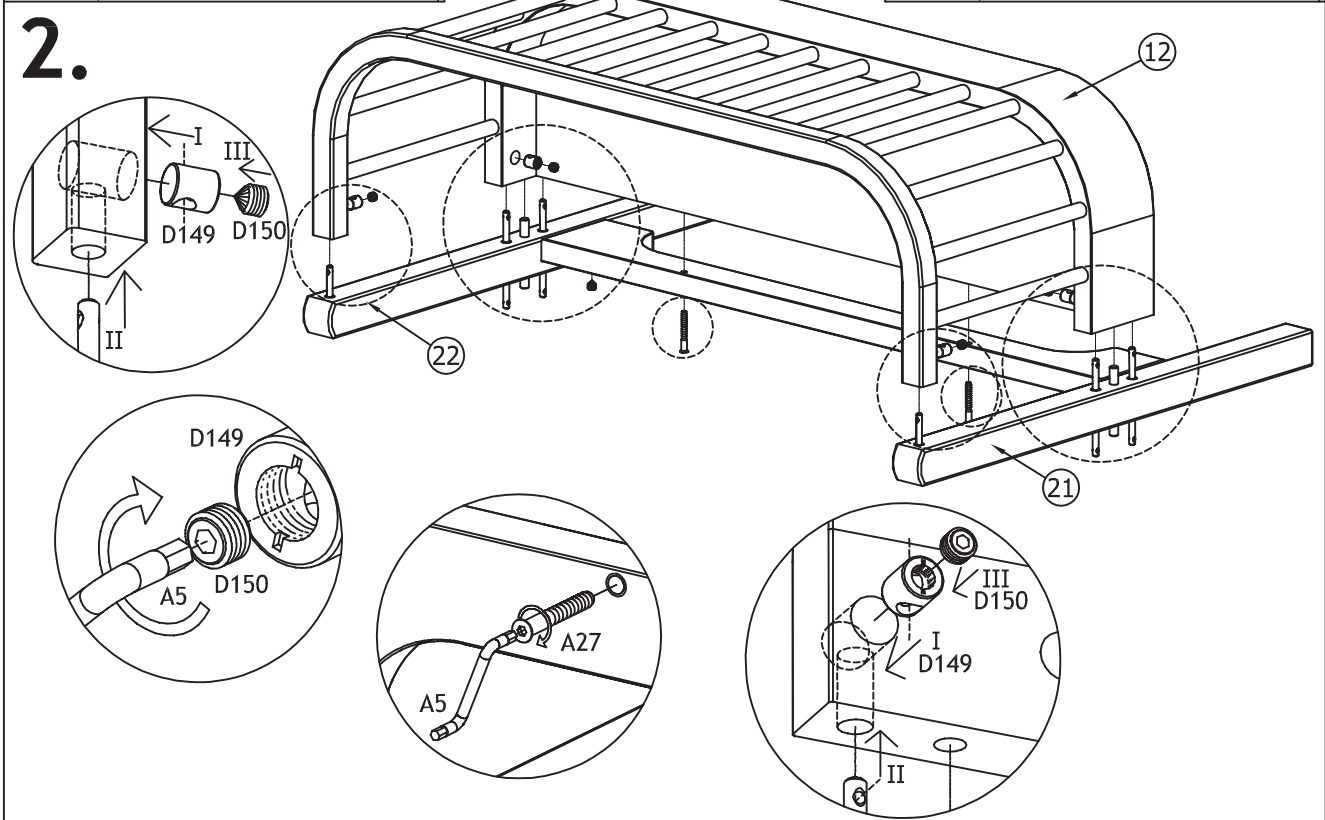
D149		x12 Ø16x20	D150		x14 M10 SW4	A27		x4 Ø7x50
A6		x1 4 mm				A5		x1 4 mm

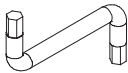
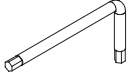

D149		x4 Ø16x20	D150		x4 M10 SW4	A5		x1 4 mm
A6		x1 4 mm						

3.

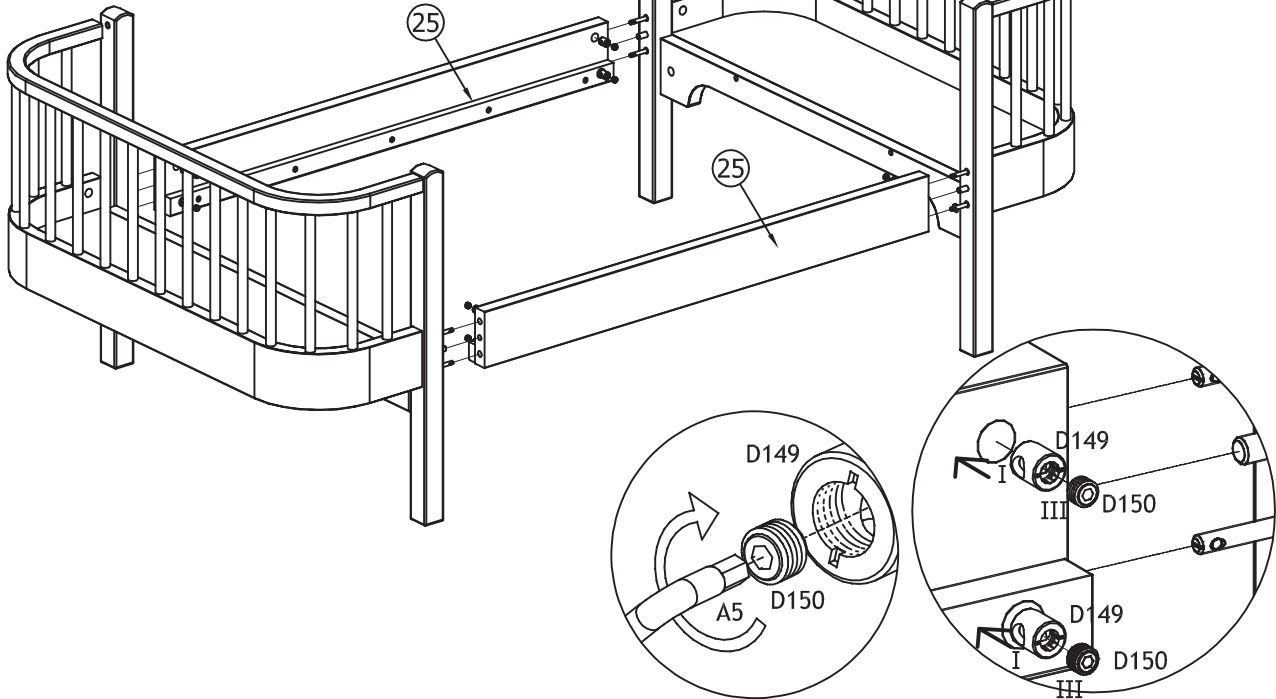

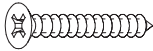
A66		x6 Ø3,5x25
-----	---	---------------

4.

