

FLOS

■ F7542031 Matte Black

To-Tie T2 NEW

Designed by Guglielmo Poletti, 2022

7W - 2700K - CRI > 90



Designed by Guglielmo Poletti Table lamp providing diffused light. Clear glass cylindrical lamp body available in multiple sizes. The handle is made of aluminum and also acts as a light emitter. Multi-led diffuser in specially designed white polycarbonate to avoid the Multi Shadow effect and dazzle. High efficiency LED source with a lifetime of more than 50.000 hours. Electric cable of useful length 180 cm, covered in black fabric and equipped with dimmer switch for ON/OFF and adjustment of the light flow between 10-100%. Plug-in power supply with interchangeable plugs. To-Tie is a future-proof lamp as no glue is used to assemble its different parts. The product can therefore be separated, replaced individually, and recycled separately.

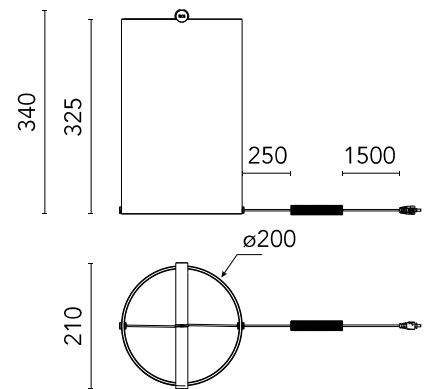

Are you a professional and your project needs consulting and support?

[BOOK AN APPOINTMENT](#)

Main specifications

EAN	8059607047620
Mounting	Table
Environment	Indoor dry location
Light source type	LED
LED type	LED Module
Power (W)	7

Physical

Colour	Matte Black
Net weight (kg)	2.5
Package volume (m3)	0.04
IP	20
H2O stop	No

Download

[Mounting instructions](#) PDF

Photometric Files

[LDT / IES](#) ZIP

Technical Drawings

[2D](#) ZIP

[3D](#) ZIP

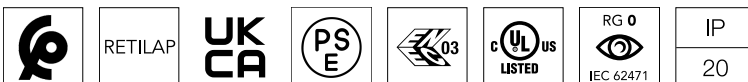

Schematic light drawing

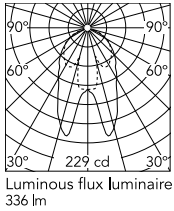

Photometric

Lighting type	Direct
Light distribution	Asymmetric
CCT (K)	2700
CRI>	90

Electrical

Insulation class	III
Frequency (Hz)	50/60
Main voltage (Vac)	24
LED voltage Vf (Vdc)	24
LED current (mA)	500
Driver	Remote included
Dimmable	Yes
Dimming type	Dimmer on board
Dimming interface	Dimmer Integrated
Plug type	Type G, Type A, Type C

Ecodesign and Energy

Labelling

This product contains a light source of energy efficiency class F



Replaceable (LED only) light source by an end-user

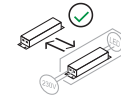

Replaceable control gear by an end-user