

Snoopy

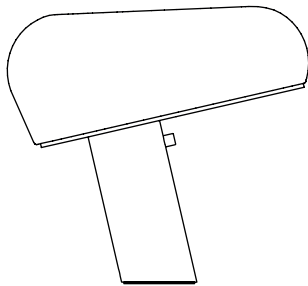

FLOS

FLOS HISTORY

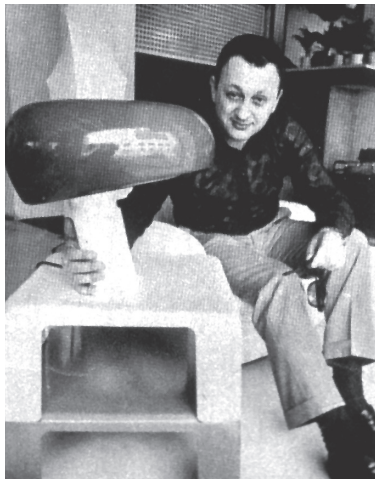

Mr. Sergio Gandini - Flos Chairman from 1965 to 1999

FLOS was founded in 1962. The very same year we began producing a number of lamps that were to become classics in Italian industrial design. These first lamps were Arco, Relemme, Toio and Taccia - all designed by Achille and Piergiacomo Castiglioni. As a tangible proof of their timeless design and technical excellence, these lamps continue to be produced today.

It all started with cocoon...

In 1959 Arturo Eisenkeil from Merano, an importer of cocoon, a spray-on plastic coating produced in the United States, was tracking down possible applications for this new material. He joined forces with Dino Gavina and Cesare Cassina and set up a company to produce lighting fixtures. This marked the beginning of our long-standing association in the area of design with the Castiglioni brothers and Tobia Scarpa. The first cocoon lamps ever created were the offspring of this collaboration: Viscontea, Taraxacum and Gatto by the Castiglioni brothers and Fantasma by Scarpa.

And then...

We moved from Merano to the province of Brescia in 1964: at first to Nave and then to our current premises in Bovezzo. Sergio Gandini became chairman of the company in 1965. In 1974, Flos became the owner of Arteluce - one of the key Italian companies in the industrial design sector. Gino Sarfatti, an industrialist and designer, is the founder of Arteluce. Several models designed by Sarfatti himself have been incorporated into our product range.

Quality is given

From the very outset, our distinguishing feature has been the high quality approach to lamp design and production. Many of the numerous lamps designed for Flos, first by Achille and Piergiacomo, are undoubtedly some of the best-known and most successful products of industrial design. They have

won awards and historical-critical accolades, and are included in all the most important collections and design museums around the world. Some significant product examples over the last forty years are: Parentesi (1970), Brera (1992), Fucsia (1996) and the recent Diabolo (1998). The revolutionary Parentesi by Achille Castiglioni and Pio Manzù is a fine thread stretched between floor and ceiling and was awarded the compasso d'Oro in 1979.

Over the years

Prominent Italian and international names have designed for Flos and Arteluce. Marc Newson created the Helice aluminum floor lamp (1992). Marc Sadler's Drop rubber wall lamp was awarded the Compasso d'Oro in 1994 - the very same year also awarded to Flos for its activity as a company. In 1988, we began producing Arà, the first Philippe Starck lamp. This was the beginning of an important working relationship that has lasted ever since. Arà was followed, among others, by the small colored Miss Sissi (1991) in plastic that turned out to be a cult object and an enormous commercial success. The following years came Rosy Angelis (1994), the Romeo Moon (1996) and Archimoon (1998) series.

In sync with time

Throughout the nineties the work of Achille Castiglioni and Philippe Starck has been flanked by a series of products from new and other designers. This reflects our desire to keep our attitude to discover the most talented designers to maintain our leadership in

innovation. We began producing Jasper Morrison's Global series in 1998, keyed by a large opaline sphere that can be used with various types of supports. Kostantin Gricic is another innovative designer and we produce two of his works: May Day that is reinventing a versatile, multi-purpose floor or suspension lamp, and Boxer redesigning a characterless type with contemporary materials and lines. Finally, we also produce Antonio Citterio's Lastra ceiling fixture. This lamp combine advanced lighting technology, printed circuitry and single adjustable task lighting with a traditional accent conjured up by the imposing crystal sheet and lamp hanging over the dining table.

Communicating design

We have the same high quality approach to the way we communicate through our catalogues and graphic image, fitting, showrooms and exhibitions. Our first catalogues were signed by Max Huber and the logo was designed by Pino Tovaglia. Today our communication takes advantage of the collaboration with international talents such as Jean Baptiste Mondino for the photography, or Ferruccio Laviani for the design of our show room.

The new millenium

Our production will continue to be imbued with various design trends that embody our attention to leading-edge research combined with highly efficient production, sales and communications. In 2002, we celebrated forty years' production of designer lamps.

THE DESIGNERS

ACHILLE CASTIGLIONI was born in Milan in 1918 and graduated with a degree in architecture in 1944. As early as 1940 he dedicated himself to testing industrial production with brothers Livio (1911-1979) and Pier Giacomo (1913-1968). After graduating, he began research into shapes, techniques and new materials, aimed at developing an integral design process. In 1969, he was authorized by the Ministry of Education to teach "Artistic Design for Industry" and was a professor at Turin's Faculty of Architecture until 1980 and then professor of "Industrial Design" in Milan until 1993. Since 1950 he has worked in the area of testing and research into outfittings and presentations for exhibitions (Triennale di Milano, Montecatini, Agip, Rai) He was one of the founders of ADI in 1956. MoMA in New York features 14 of his works. Other works can be found at: Victoria and Albert Museum (London), Kunstgewerbe Museum (Zurich), Staatliches Museum fur Angewandte Kunst (Munich), Museo del Design (Prato), Uneeleckoprumslove Prague Museum, Israel Museum (Jerusalem), The Denver Art Museum, Vitra Design Museum (Weil am Rhein), Angewandte Kunst Museum (Hamburg and Cologne). He has been awarded 9 Compasso d'Oro. He staged a one-man show between 1984 and 1986 organized by the Museum fur Angewandte Kunst (Vienna), then at Akademie der Kunst (Berlin), Triennale di Milano (Milan), Kunstgewerbe Museum (Zurich), Haags Gemeentemuseum (the Hague), Circulo de Bellas Artes (Madrid) and at the Centre Georges Pompidou (Paris). 1985: Honorary Member of the "Committee of Advisors" at Art Center College of Design (Pasadena, California and Montreaux, Switzerland). 1986: Honorary Member of the

Faculty of Royal Designers for Industry, Royal Society of Art (London). 1987: Honorary Degree from the Royal College of Art (London). 1993: Annual award from "The Chartered Society of Designers" (London). 1994: "Primavera del Design" Award from the Department of Culture (Catalonia). 1995: "Art sur Table" Award from the Conseil National des Art Culinaire (Paris). 1996: "IF Design Wettbewerb" Award from Industrie Forum Design (Hanover). 1996: "Longevity-Langlebigkeit" Award from Design Center (Stuttgart). 1999: "Domus/INARCH 1998 Award" alla carriera from INARCH. 1999: "Targa d'Oro Unione Italiana per il Disegno" Award from the Faculty of Architecture of Genoa. 1999: Wins the Enel "Sostegni per l'Ambiente" competition together with architect Michele De Lucchi. Achille Castiglioni died in 2002.

PIER GIACOMO CASTIGLIONI was born in Milan in 1913. He graduated from the department of Architecture at Milan Polytechnic in 1937. He began working with his younger brother Achille, immediately after the war, directing his interests toward urban planning, architecture and design in a multivarious and intense professional enterprise, contributing actively to international cultural life by participating in numerous conferences and round tables, most of them focused on industrial design. He is known, with his brother, throughout the world for their designs for lighting fixtures and furniture. In 1956, he was among the founding members of the A.D.I. (Industrial Design Association). His expertise and interests led him into the field of teaching; Pier Giacomo was professor of Architectural Composition at Milan Polytechnic until he died in 1968.



Achille and Pier Giacomo Castiglioni



IT

ISTRUZIONI DI INSTALLAZIONE ED IMPIEGO

ATTENZIONE!

La sicurezza dell'apparecchio é garantita solo rispettando queste istruzioni sia in fase di installazione che di impiego; é pertanto necessario conservarle.

AVVERTENZE:

- All'atto dell'installazione ed ogni volta che si interviene sull'apparecchio, assicurarsi che sia stata tolta la tensione di alimentazione.
- Il simbolo  riportato sull'apparecchio indica la necessità di utilizzare lampade di tipo autoprotetto.
- Il simbolo  riportato sull'apparecchio indica che il prodotto deve essere smaltito in modo differenziato dai rifiuti urbani.
- L'apparecchio non può essere in alcun modo modificato o manomesso, ogni modifica ne può compromettere la sicurezza rendendo lo stesso pericoloso. FLOS declina ogni responsabilità per i prodotti modificati.
- Se il cavo flessibile si danneggia, deve essere sostituito da FLOS o da personale qualificato al fine di evitare pericoli.

DATI TECNICI EUR

Lampadina incandescente ad alogeni MAX 150W attacco E27 tipo HSGS.

ISTRUZIONI PER LA PULIZIA DELL'APPARECCHIO

- Per la pulizia dell'apparecchio utilizzare esclusivamente un panno morbido eventualmente inumidito con acqua e sapone.
- **Attenzione:** non utilizzare alcool o solventi.



EN

INSTRUCTION FOR CORRECT INSTALLATION AND USE

WARNING!

The safety of this fitting can only be guaranteed if these instructions are observed, during both installation and use. Please retain these instructions safety.

REMARKS:

- When installing and each time work must be done on the lamp, make sure it is not connected to a power point.
- The symbol  marked on the appliance indicates the need to use self-protected bulbs.
- The symbol  shown on the device indicates that the product must be thrown out in a different manner than with the urban trash.
- The appliance may in no way be modified or tampered with, any modification may compromise safety causing the appliance to become dangerous. FLOS declines all responsibility for products that are modified.
- Should the external trailing cable get damaged, it must be replaced by FLOS or by qualified personnel in order to avoid any danger.

TECHNICAL DATA EUR

Incandescent halogen bulb MAX 150W, E27 fitting, type HSGS.

TECHNICAL DATA USA

Incandescent halogen bulb MAX 75W, E26 fitting, type T.

CLEANING INSTRUCTIONS

- Use only a soft cloth to clean the appliance, dampened with water and soap or mild cleanser if needed for resistant dirt.
- **Warning:** do not use alcohol or other solvents.



DE

INSTALLATION - UND GEBRAUCHSANWEISUNGEN

ACHTUNG!

Wir garantieren nur dann für die Sicherheit der Leuchte, wenn diese Anweisungen sowohl bei der Installation als auch beim Gebrauch genau beachtet werden. Es ist daher ratsam, sie aufzubewahren.

BEMERKUNGEN:

- Beim Installieren und jedesmal, wenn irgendwie auf die Lampe eingewirkt wird, versichern Sie sich, daß die Spannungsleitung entfernt ist.
- Das auf der Leuchte wiedergegebene Symbol  zeigt an, dass Glühbirnen des selbstschützenden Typs zu benutzen sind.
- Das auf dem Gerät wiedergegebene Symbol  zeigt an, dass das Produkt getrennt vom Stadtmüll entsorgt werden muss.
- Der Apparat darf auf keinen Fall veraendert oder unerlaubt geoeffnet werden, jede Veraenderung desselben kann die Sicherheit in Frage stellen und somit gefaehrlich werden. FLOS lehnt jede Verantwortung fuer unsachgemaess behandelte Produkte ab.
- Falls das flexible äußere Kabel beschädigt wird, muß es von FLOS oder von qualifiziertem Personal ersetzt werden, um Gefahren zu vermeiden.

TECHNISCHE DATEN EUR

Halogen-Glühlampe MAX 150W Fassung E27 Typ HSGS.

REINIGUNGSVORSCHRIFTEN

- Bei der Reinigung der Leuchte darf man ausschließlich weiche Tücher verwenden. Eventuell kann man diese mit Wasser und Seife oder mit einem neutralen Reinigungsmittel anfeuchten.
- **Achtung:** Weder Alkohol noch Lösungsmittel verwenden.



FR

INSTRUCTIONS D'INSTALLATION ET D'EMPLOI

ATTENTION!

La sûreté de cet appareil est garantie uniquement si l'on respecte ces instructions soit en phase d'installation soit pendant l'utilisation; il faut donc les conserver.

NOTICES:

- Au moment de l'installation et chaque fois que l'on intervient sur l'appareil, s'assurer que la tension d'alimentation ait été coupée.
- Le symbole  reporté sur l'appareil indique la nécessité d'utiliser des ampoules de type "auto-protégé".
- Le symbole  reporté sur l'appareil indique que le produit doit être éliminé d'une autre façon que celle avec les déchets urbains.
- L'appareil ne peut être modifié ou altéré de quelque manière que ce soit, toute modification peut compromettre la sécurité de celui-ci en le rendant dangereux. FLOS décline toute responsabilité pour les produits modifiés.
- Si le cordon flexible externe est endommagé, il doit être remplacé par FLOS ou par le personnel qualifié afin d'éviter des dangers.

DONNEES TECHNIQUES EUR

Ampoule incandescente à halogènes 150W MAX, raccord E27 type HSGS.

DONNEES TECHNIQUES USA

Ampoule incandescente à halogènes 75W MAX, raccord E26 type T.

INSTRUCTIONS POUR LE NETTOYAGE



- Pour le nettoyage de l'appareil utiliser exclusivement un chiffon doux, humecté si nécessaire, avec de l'eau et du savon ou avec un détergent neutre pour les salissures les plus tenaces.
- **Attention:** ne pas utiliser d'alcool ou solvants.

INSTRUCCIONES DE INSTALACIÓN Y DE USO

¡ATENCIÓN!

La seguridad del aparato sólo puede garantizarse con la condición de que se respeten las siguientes instrucciones, tanto en la fase de instalación como de uso, por lo cual se recomienda conservarlas.

ADVERTENCIA:

- Para efectuar la instalación, y toda vez que se efectúe alguna operación en el aparato, asegurarse de haber cortado la corriente eléctrica.
- El símbolo  marcado en el aparato indica la necesidad de utilizar bombillas de tipo autoprotegido.
- El símbolo  marcado en el aparato indica que el producto debe ser eliminado en modo diferenciado del resto de los desechos urbanos.
- El aparato no puede ser en ningún caso modificado o forzado, cualquier modificación puede comprometer la seguridad haciéndolo peligroso. FLOS declina cualquier responsabilidad por los productos modificados.
- Si el cable externo se estropea, debe ser sustituido por FLOS o por personal cualificado con el fin de evitar situaciones peligrosas.

DATOS TECNICOS EUR

Lámpara halógena de incandescencia MÁX 150 W casquillo E27 tipo HSGS.

DATOS TECNICOS USA

Lámpara halógena de incandescencia MÁX 75W casquillo E26 tipo T.

INSTRUCCIONES PARA LIMPIAR EL APARATO



- Para la limpieza del aparato, utilizar exclusivamente un paño suave. En caso de suciedad más resistente, humedecer el paño con agua y jabón o un detergente neutro.
- **Advertencia:** no emplear alcohol ni disolventes.

INSTRUÇÕES INSTALAÇÃO E USO

ATENÇÃO!

A segurança do aparelho é garantida somente se respeitarmos as instruções tanto na fase de instalação como na de uso; portanto é necessário conservar tais instruções.

ADVERTÊNCIA:

- Para efectuar a instalação, y toda vez que se efectúe alguna operación en el aparato, asegurarse de haber cortado la corriente eléctrica.
- O símbolo  indicado no aparelho indica a necessidade de utilizar lâmpadas com blindagem externa.
- O símbolo  indicado no aparelho indica que o produto deve ser eliminado de forma diferenciada em relação ao lixo urbano.
- De forma alguma o aparelho deve ser modificado ou alterado, toda e qualquer modificação pode comprometer a segurança tornando o aparelho perigoso. FLOS declina toda e qualquer responsabilidade pelos produtos modificados.
- Se o cabo flexível está danificado, deve ser substituído pela FLOS ou por pessoal qualificado para evitar qualquer perigo.

DADOS TÉCNICOS EUR

Lampadina incandescente MAX 150W, ligação E27, tipo HSGS.

INSTRUÇÕES PARA A LIMPEZA DO APARELHO

- Para limpeza do aparelho utilizar exclusivamente um tecido macio eventualmente úmido com água e sabão ou detergente neutro para a sujeira mais difícil.
- **Atenção:** não utilizar álcool ou solventes.

ИНСТРУКЦИИ ПО МОНТАЖУ И ПРИМЕНЕНИЮ

ВНИМАНИЕ!

Надёжность устройства гарантируется только при соблюдении данных инструкций, как в фазе монтажа, так и при применении, поэтому необходимо обеспечить их сохранность.

ПРЕДУПРЕЖДЕНИЯ:

- В момент установки и каждый раз при проведении работ с устройством, убедиться в снятии напряжения питания.
- Обозначение  приведённое на устройстве, указывает на необходимость использования самозащищаемых лампочек.
- Символ  приведённый на устройстве, указывает на то, что данная продукция должна быть переработана отдельно от городских отходов.
- Устройство не может изменяться или разбираться, любые изменения могут нарушить надёжность, делая его опасным. FLOS не несёт ответственность за изменённую продукцию.
- При повреждении гибкого кабеля он должен заменяться FLOS или квалифицированным персоналом в целях предотвращения опасности.

ТЕХНИЧЕСКИЕ ДАННЫЕ EUR

Лампа накаливания макс.150Вт. цоколь E27, тип HSGS.

ИНСТРУКЦИИ ПО ОЧИСТКЕ УСТРОЙСТВА



- Для очистки устройства использовать только мягкую тряпку, смоченную водой с мылом или нейтральным моющим средством для наиболее стойких загрязнений.
- **Внимание:** Не использовать спирт или другие растворители.

取り付けおよびご使用方法

警告

安全な器具の取り付けおよびご使用のために、取扱説明書に従って作業を行ってください。また、取扱説明書は必ず保管してください。

注意

- 取り付け作業および取り外しや再取り付け時には、必ず電源を切ってください。
- 器具上の表示  は、破損防止形または飛散防止形の電球の使用を表します。
- 器具上の表示  は、一般ごみと区別し本製品を廃棄しなければならぬことを表しますアメリカ対応のみ高温発光です。
- 危険ですので、器具を改造したり、部品を追加・変更して使用しないでください。改造した製品に対しては、FLOSは一切責任を負いません。
- 電気接続に精通していない場合は、有資格の電気技術者に連絡してください。

技術的な仕様 USA

白熱ハロゲン球 最大75W、口金E26、Tタイプ。

器具の清掃について



- 器具の清掃には、柔らかい布を使用してください。落ちにくい汚れは、柔らかい布を石鹸水または薄めた中性洗剤に浸し、十分に絞ってから拭き取ってください。
- 注意：アルコールや溶剤などは使用しないでください。

正确安装指南和使用说明

注意！

在安装和使用过程中，电器的安全性只能通过遵守说明得到保证；因此请务必保留此说明。

警告：

- 安装以及调试电器时，请确保电源电压已被移除。
- 设备上显示的  符号表示需要使用自我保护型灯具。
- 设备上显示的  符号表示该产品必须与城市垃圾分开处理。
- 本产品不得以任何方式进行改动或改装，任何改动都可能危及其安全。FLOS拒绝承担改装产品的责任。
- 如果柔性电缆损坏，则必须由FLOS或有资质的人员进行更换，以避免危险。

欧标技术数据

MAX 150W 卤素白炽灯泡，HSGS型号E27插头。

电器清洁说明



- 只能使用沾上水和肥皂的软布清洁电器。
- 注意：不要使用酒精或溶剂。

لامعتسلاو بيكرتلاب ةصاخ تاداشرإ

!هينت!

لا يمكن ضمان سلامة هذا التركيب إلا إذا روعيت هذه التعليمات أثناء التركيب والاستعمال. يرجى حفظ تعليمات السلامة هذه.

ملاحظات:

- عند القيام في التركيب وفي كل مرة يبرد القيام بأي تدخل على الجهاز، التأكد أولا من القيام بفصل جهد الترمين الكهربائي.
- العلامة  الموجودة على الجهاز تشير إلى ضرورة استعمال مصابيح ذات الوقاية الذاتية.
- العلامة  الموجودة على الجهاز تشير إلى أن التخلص النهائي من الجهاز يجب أن يتم على انفراد ومنفصل عن النفايات المدبنة.
- لا يمكن القيام بأي تعديل أو تغيير في الجهاز بأي شكل من الأشكال. كل تغيير قد يخل في أمان الجهاز جاعلا هذا الأخير خطيرا. (FLOS) لا تتحمل أية مسؤولية تجاه الأجهزة التي تعرّضت إلى تغييرات أو تعديلات.
- في حالة تعرّض السلك المرن إلى ضرر، من الضروري أن يتم تبديله من قبل (FLOS) أو من قبل أشخاص مؤهلين ذوي الخبرة لتحايد التعرض إلى المخاطر.

المعلومات التقنيّة

مصباح متأجج بهالوجينات حد أقصى 150 واط ربط (E27) نوع (HSGS).

إرشادات لتنظيف الجهاز

- لتنظيف الجهاز استعمال فقط قطعة قماش ناعمة، التي من الممكن أن تكون مرطبة بالماء والصابون أو مادة تنظيف محايدة لتنظيف الوسخ.
- الشديد. تنبيه: عدم استعمال الكحول أو مواد الإذابة.

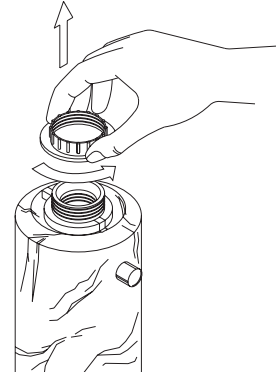

Fig. 2

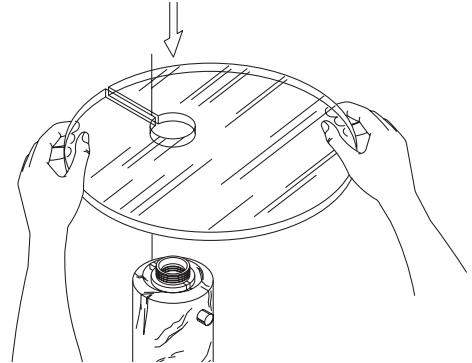
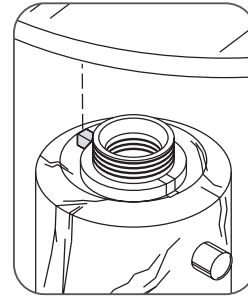

Fig. 3

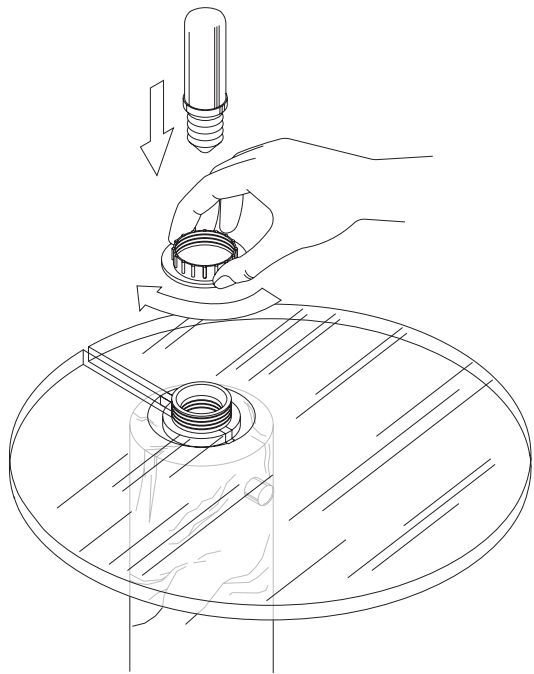

Fig. 4

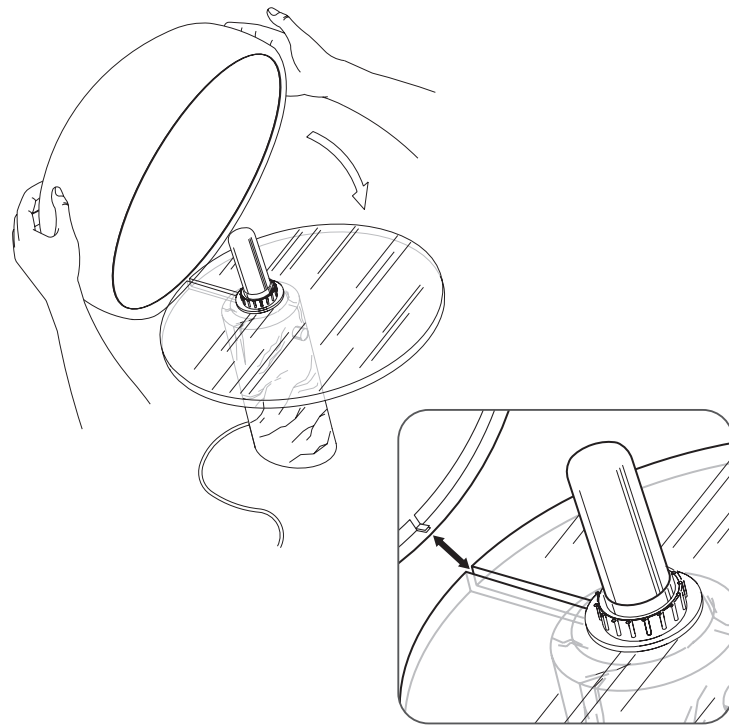
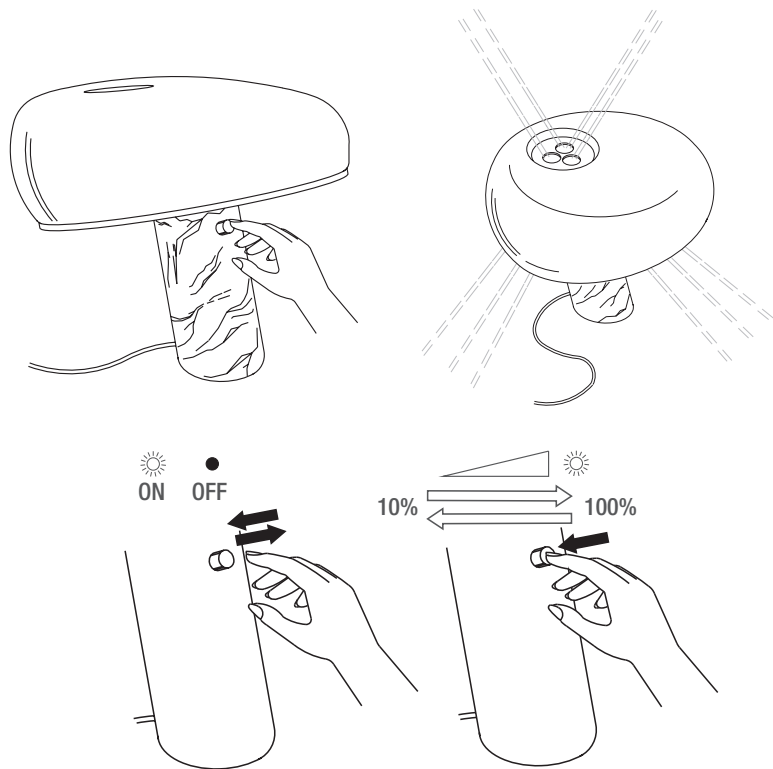

Fig. 5



IT

Fig.5 Per l'accensione / spegnimento dell'apparecchio effettuare un breve tocco del sensore (S); un contatto prolungato dello stesso provoca il decremento progressivo dell'intensità luminosa dal 100% fino al 10%; Al raggiungimento dell'intensità desiderata, interrompere il contatto con il sensore. Un successivo contatto prolungato del sensore ne provocherà l'incremento progressivo. **NOTA:** Grazie alla memoria del dimmer, quando l'apparecchio viene riacceso (anche da interruttore a parete) , si riaccende allo stesso livello d'intensità luminosa impostato al momento dello spegnimento; la funzione dimmer è attivabile solo tramite il sensore (S).

EN

Pic.5 To switch the appliance on / off, touch the sensor (S) briefly. Prolonged contact with the sensor gradually reduces the light intensity from 100% to 10%. When you obtain the required intensity, release the sensor. A new prolonged contact with the sensor will gradually increase the light intensity. **NOTE:** Due to the dimmer memory, when the appliance is switched on again (from the wall switch or otherwise), it goes to the same level of light intensity that it was set to before being switched off. The dimmer function can only be activated through the sensor (S).

DE

Abb.5 Zum Ein-/Ausschalten der Leuchte genügt ein kurzes Berühren des Sensors (S); bei einem längeren Kontakt mit dem Sensor verringert sich die Helligkeit schrittweise von 100% auf bis zu 10%; bei Erreichen der gewünschten Helligkeit, den Kontakt mit dem Sensor unterbrechen. Eine nachfolgende längerere Berührung des Sensors verstärkt die Helligkeit schrittweise. **ANMERKUNG:** Dank des Speichers des Dimmers schaltet sich die Leuchte beim nächsten Einschalten (auch über den Wandschalter) mit derselben Helligkeitstufe ein, die beim Abschalten eingestellt war; die Dimmer-Funktion ist nur über den Sensor (S) aktivierbar.

FR

Fig.5 Pour allumer/éteindre l'appareil, toucher légèrement le capteur (S); un contact prolongé sur le capteur provoque la baisse progressive de l'intensité lumineuse de 100% jusqu'à 10%. Une fois le niveau d'intensité obtenu, interrompre le contact avec le capteur. Le prochain contact prolongé du capteur provoquera l'augmentation progressive de l'intensité. **NOTA BENE:** grâce à la mémoire du variateur, lorsque l'appareil est rallumé (même si c'est au moyen d'un interrupteur mural), la lampe se rallume au même niveau d'intensité lumineuse qu'elle avait lorsqu'elle a été éteinte ; la fonction de variation ne peut être activée qu'au moyen du capteur (S).

ES

Imag.5 Para encender/apagar el dispositivo, tocar brevemente el sensor (S); el contacto prolongado del mismo tiene como consecuencia una disminución progresiva de la intensidad luminosa desde el 100 % al 10 %; una vez conseguida la intensidad deseada, interrumpa el contacto con el sensor. Un posterior contacto prolongado del sensor tendrá como consecuencia un aumento progresivo. **NOTA:** Gracias a la memoria del regulador, cuando se vuelva a encender el dispositivo (también con el interruptor de pared), se enciende en el mismo nivel de intensidad luminosa configurado en el momento en el que se apagó; la función del regulador se puede activar solo a través del sensor (S).

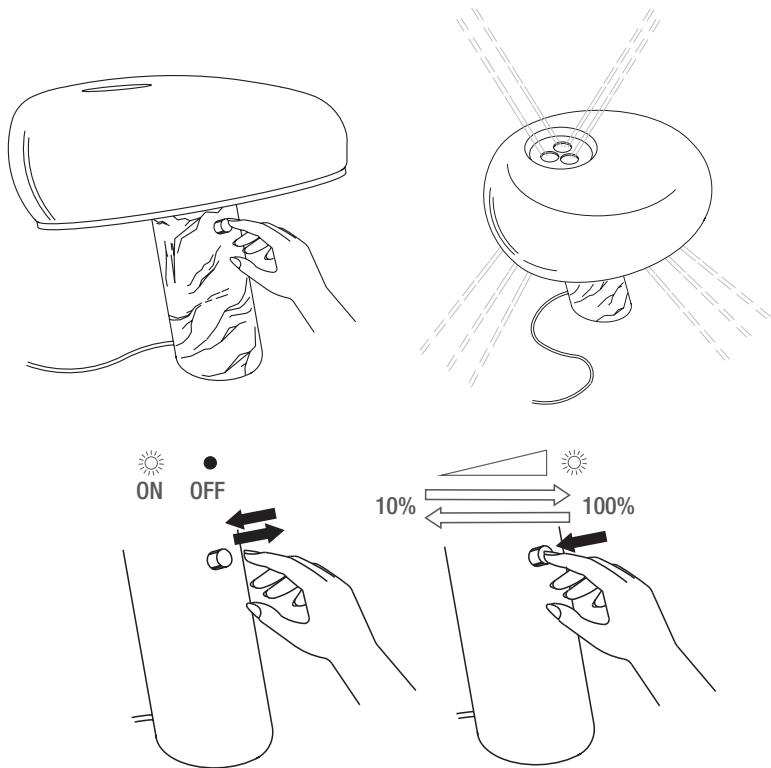

ES Fig.5 Para ligar/desligar o aparelho tocar brevemente no sensor (S). O contacto prolongado do mesmo provoca o decréscimo progressivo da intensidade luminosa de 100% até 10%. Ao atingir a intensidade desejada, interromper o contacto com o sensor. Um posterior contacto prolongado do sensor provoca o aumento progressivo. **NOTA:** graças à memória do dimmer, ao voltar a ligar o aparelho (também através do interruptor de parede) este activa-se no mesmo nível de intensidade luminosa programado no momento da desactivação. A função dimmer pode ser activada apenas através do sensor (S).

RUS **Рис.5** Для включения /выключения устройства кратко нажмите сенсор (S); длительное нажатие на сенсор вызывает прогрессивное уменьшение интенсивности света от 100% до 10%; При достижении желаемой интенсивности света уберите руку с сенсора. Последующее длительное прикосновение к сенсору вызовет прогрессивное увеличение интенсивности. **ПРИМЕЧАНИЕ:** Благодаря памяти диммера, при включении (также с помощью настенного выключателя) устройство имеет ту же интенсивность света, что и в момент выключения, функция диммера может быть активирована только с помощью сенсора (S).

J 図5. 器具を点灯 /消灯させるには、センサー (S) に軽く触れます。センサーに触れ続けると、明るさの度合いが10%から100%まで漸増し、好みの明るさに達したらボタンから指を離します。続いてセンサーに触れ続けると漸減させることができます。メモ：デイマーメモリーにより、器具が再び点灯する時（壁のスイッチにより点灯する場合も同様）、消灯時の設定と同じ明るさに再び点灯します。デイマー機能はセンサーによってのみアクティブ化されます。

CN 图5. 该装置通过短按感应按钮 (S) 进行开启/关闭; 如果长按该按钮可以调节光亮强度, 从100%降低到10%; 当达到所需的光亮强度时, 松开按钮。此后, 再次长按该按钮, 可以逐渐增加光亮强度。备注: 调光器带有记忆功能, 当装置再次开启时 (包含壁式开关), 光亮强度保持关闭前设置的亮度; 调光器的其他功能只能通过感应按钮 (S) 实现。

SA (S) شكل 5. لإضاءة/ إطفاء الجهاز، يجب الضغط ضغطة قصيرة على الحساس الضوئي (S) اتصالاً مطولاً بنفس الجهاز يُفعل التناقص التدريجي للكثافة الضوئية من 100% لحد 10%؛ وبالوصول للكثافة المطلوبة، يتم فصل الاتصال مع الحساس الضوئي. تواصل تالي مطول للحساس الضوئي سوف ينتج عن الإزدياد التدريجي. ملحوظة: يفضل ذاكرة ديمر، عندما يتم إضاءة الجهاز مرة أخرى (حتى بواسطة مفتاح على الحائط)، يُثار بنفس مستوي الكثافة الضوئية الموجودة منذ لحظة الاطفاء؛ وظيفة مفتاح الديمر تنشط فقط من خلال الحساس الضوئي (S).

Fig. 6

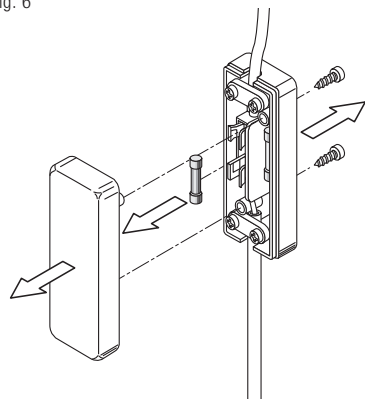

Fig. 8

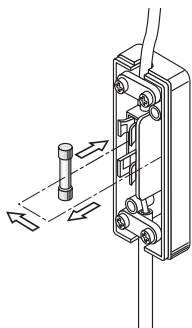

Fig. 7

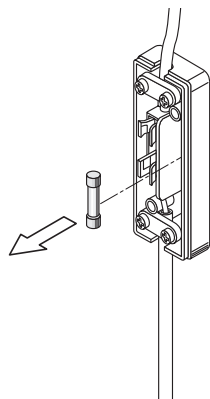
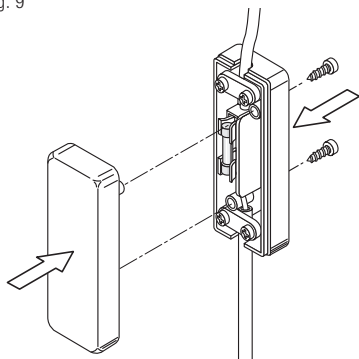

Fig. 9



IT Sostituzione fusibile di linea (5x20 250V EUR F0,8A - USA: F1,6A).

EN Replacement of line fuse (5x20 250V EUR F0,8A - USA: F1,6A).

DE Auswechslung Leitungssicherung (5x20 250V EUR F0,8A - USA: F1,6A).

FR Substitution fusible de ligne (5x20 250V EUR F0,8A - USA: F1,6A).

ES Sustitución fusible de línea (5x20 250V EUR F0,8A - USA: F1,6A).

PT Substituição do fusível del linha (5x20 250V EUR F0,8A - USA: F1,6A).

RUS Замена предохранителя линии (5x20 250V EUR F0,8A - USA: F1,6A).

J ラインヒューズの交換 (5x20 250V EUR F0,8A - USA: F1,6A)。

CN 保险丝更换 (5x20 250V欧标F0,8A - 美标 : F1.6A)。

SA .(F1,6A :USA - F0,8A EUR 250V 5x20) استبدال مصهر الخط

