

OBS! Note! Achtung!

Check at du har alle kasser før du starter
Before start please check that you have all boxes
Bitte überprüfen Sie, dass Sie alle Boxen haben

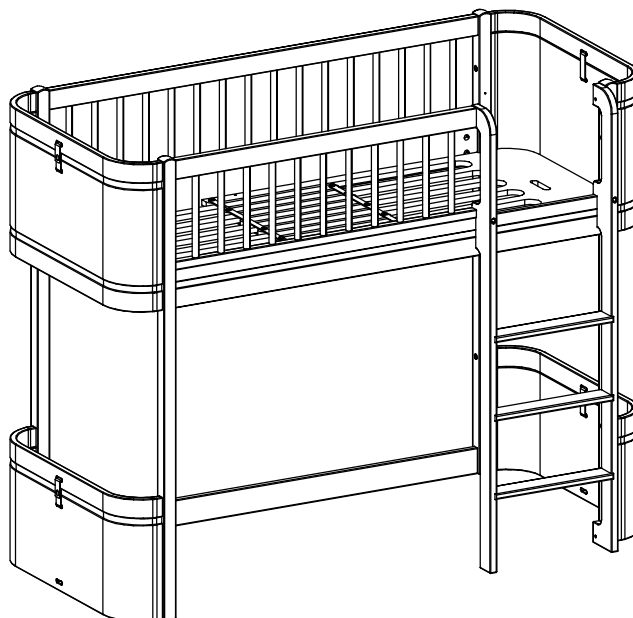

041447 Mini+ halvhøj seng Mini+ low loft bed Mini+ halbhohes Hochbett

Colis-Nr. * Package-no. Pakke nr.	Anzahl Quantities Antal	Maß, cm Dimensions, cm Størrelse, cm	✓
051454	1	148 x 73 x 11	
051477	1	98 x 41 x 16	
051478	1	98 x 48 x 16	
051483	1	148 x 15 x 10	
051485	1	146 x 45 x 12	

*Pakkenr. på ombygningskit kan variere

*Package-no. for conversion kits can vary

*Colis-Nr. für Umbauset können variieren

OBS! Note! Achtung!

Check at du har alle kasser før du starter
Before start please check that you have all boxes
Bitte überprüfen Sie, dass Sie alle Boxen haben

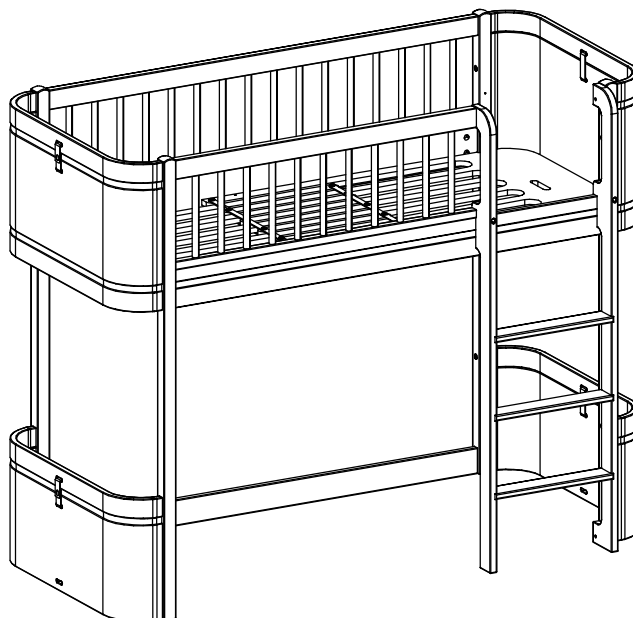

041448 Mini+ halvhøj seng Mini+ low loft bed Mini+ halbhohes Hochbett

Colis-Nr. * Package-no. Pakke nr.	Anzahl Quantities Antal	Maß, cm Dimensions, cm Størrelse, cm	✓
051454	1	148 x 73 x 11	
051477	1	98 x 41 x 16	
051478	1	98 x 48 x 16	
051484	1	148 x 15 x 10	
051486	1	146 x 45 x 12	

*Pakkenr. på ombygningskit kan variere

*Package-no. for conversion kits can vary

*Colis-Nr. für Umbauset können variieren

Wood

041447/041448 Mini+ halvhøj seng
041447/041448 Mini+ low loft bed
041447/041448 Mini+ halbhohes Hochbett

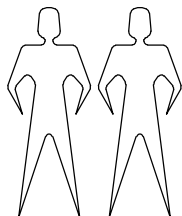

OLIVER FURNITURE A/S
Ndr. Strandvej 119 A
3150 Hellebæk
Denmark

Tel. +45 4970 7317
www.oliverfurniture.com









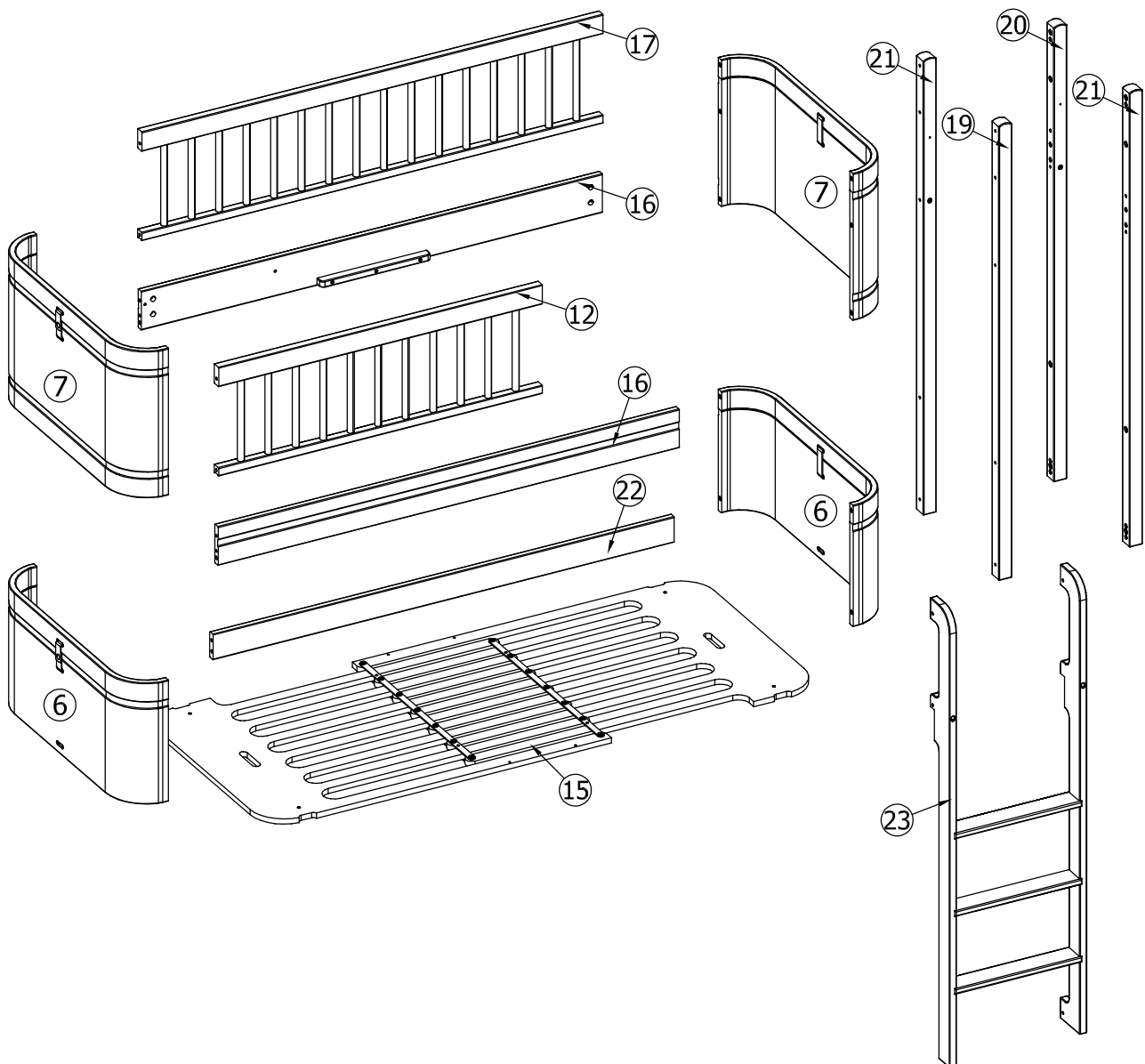

Teil-Nr. Pieces-no. Enheds. Nr.	Anzahl Quantities Antal	Colis-Nr. Package-no. Pakke nr.	Maß, mm Dimensions, mm Størrelse, mm	✓
6**	2	051477	723 x 351 x 120	
7**	2	051478	723 x 425 x 120	
12	1	051454	942 x 315 x 24	
15	1	051454	1610 x 679 x 28	
16	2	051454	1342 x 112 x 42	
17	1	051454	1342 x 315 x 24	
19	1	051483/051484	1320 x 38 x 38	
20	1	051483/051484	1320 x 38 x 38	
21	2	051483/051484	1320 x 38 x 38	
22	1	051485/051486	1342 x 74 x 18	
23	1	051485/051486	1314 x 400 x 105	

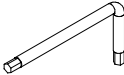
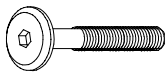
**If you have a conversion kit, please see last page: "Conversion possibilities"

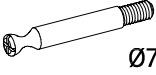
**Har du et ombygningskit, se mere på sidste side under: "ombygningsmuligheder"

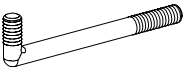
**Haben Sie ein Umbauset, dann bitte auf der letzte Seite unter: "Umbau Möglichkeiten" lesen.

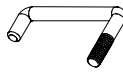
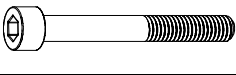
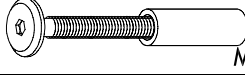
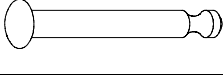
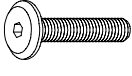
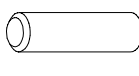

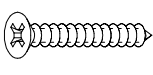
A6		x1 4 mm	A24		x16 Ø15/M6x45	D197		x16 M10x7,5
D198		x15 Ø7x34 M6 SISO	D196		x16 Ø15x14	A103		x4 M6/Ø15x12
D169		x4	C18		x4 Ø8,4/Ø15	D221		x2 M6
A237		x4 M6x50	A236		x2 M6x60	D223		x1 Ø7x60
A83		x2 M6x35	H1		x4 Ø8x30	A243		x1 5 mm
A66		x4 Ø3,5x25						

Start på et plant og jævnt underlag. Brug eventuelt pap fra emballagen som underlag.

Vær opmærksom på, at når sengen er i løse dele, er den meget udsat for lakskeader på hjørner og kanter. Man skal derfor være meget forsigtig, når sengen samles.

It is a good idea to assemble the bed on a smooth and even surface. Use the cardboard from the packaging as underlay.

Be aware that the bed is very exposed to lacquer damage on the corners and edges due to all the different parts. Therefore you must be very careful when assembling the low loft bed.

Fangen Sie auf eine ebene und gerade Unterlage an.

Die Pappe von der Verpackung können Sie eventuell als Unterlage benutzen.

Seien Sie darauf aufmerksam, dass das Bett solange es zerlegt ist, sehr empfindlich gegenüber Lackschäden an Ecken und Kanten ist. Die Montage soll daher vorsichtig gemacht werden. Achten Sie darauf, die gewindeschrauben NICHT ganz festzuspannen ehe das Bett fertig montiert ist.

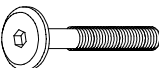
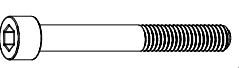
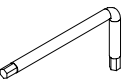
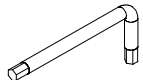
A24		Ø15/M6x45 x16	A237		M6x50 x4
A6		x1 4 mm	A243		x1 5 mm

1.

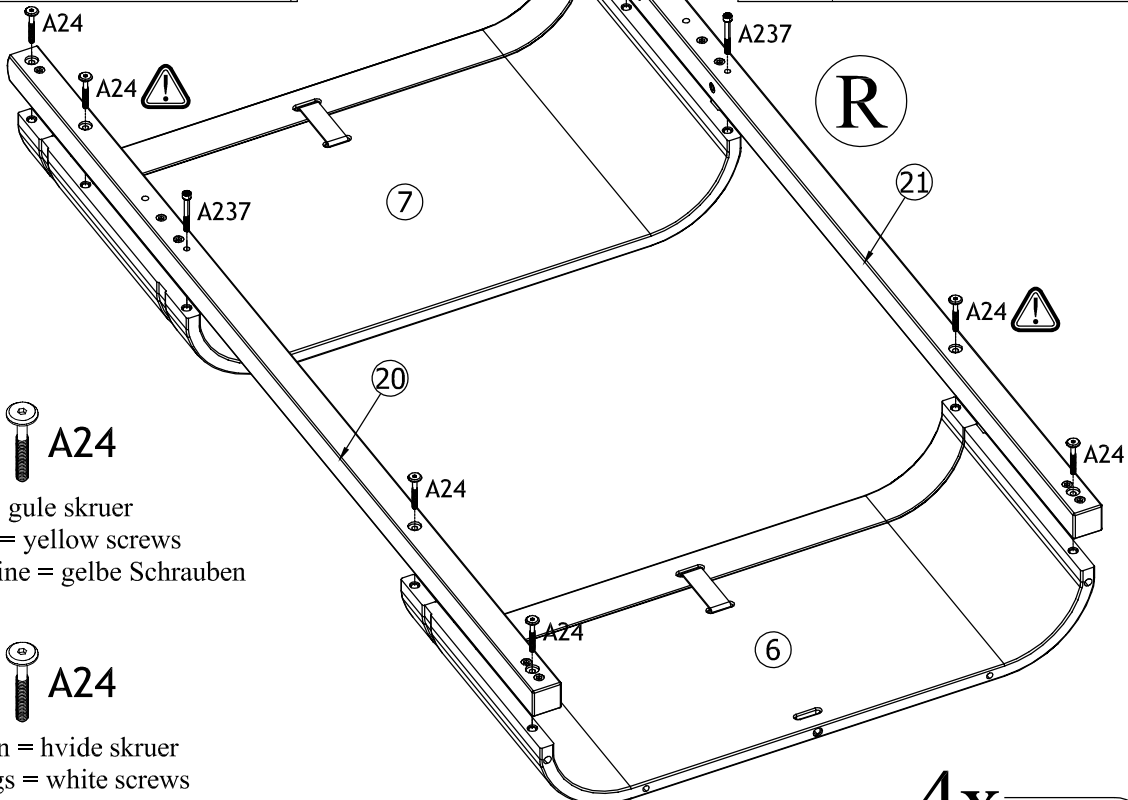

Egeben = gule skruer
Oak legs = yellow screws
Eiche Beine = gelbe Schrauben



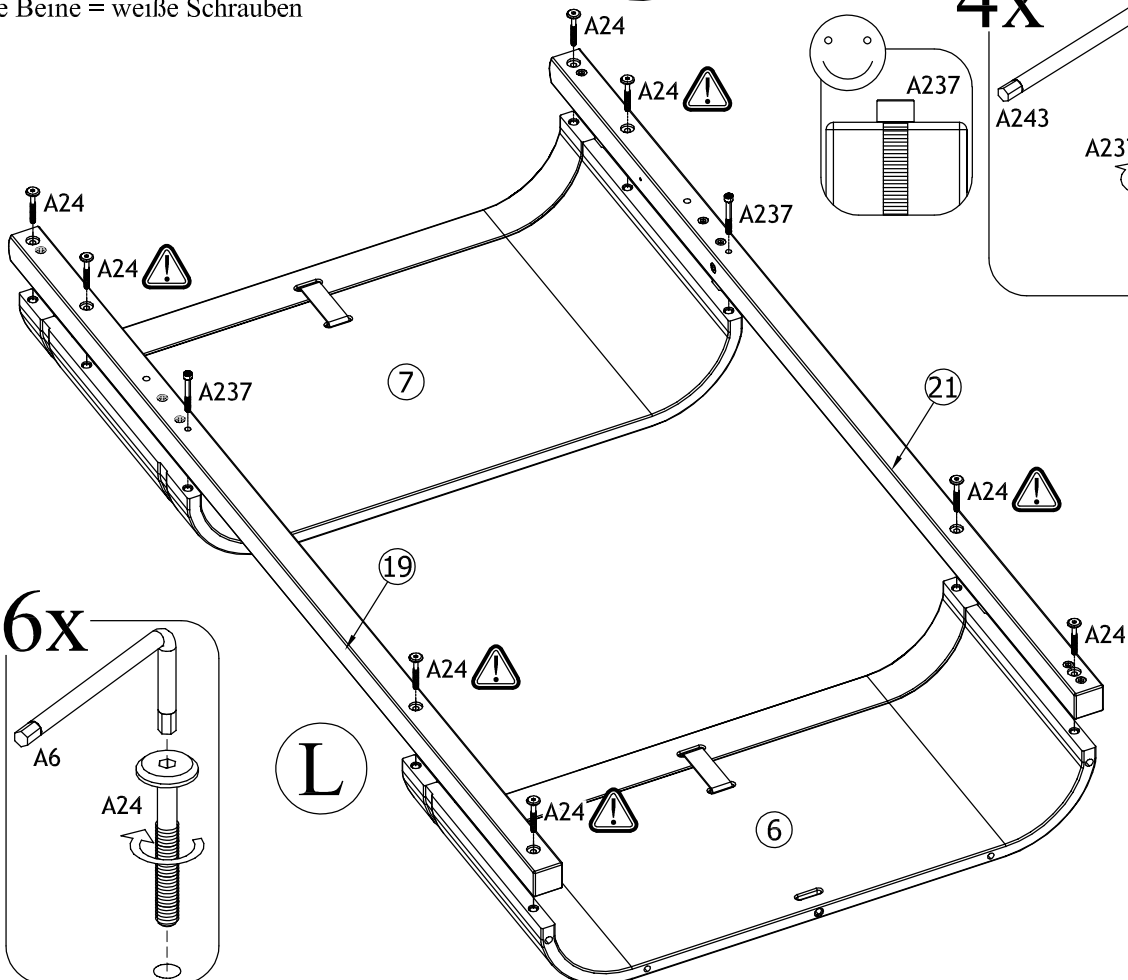
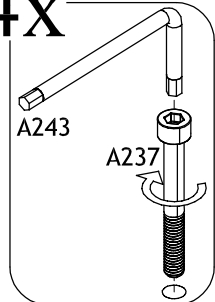
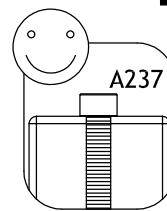

Hvide ben = hvide skruer
White legs = white screws
Weiße Beine = weiße Schrauben

4x



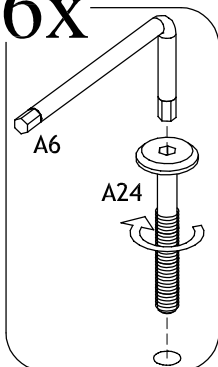





16x

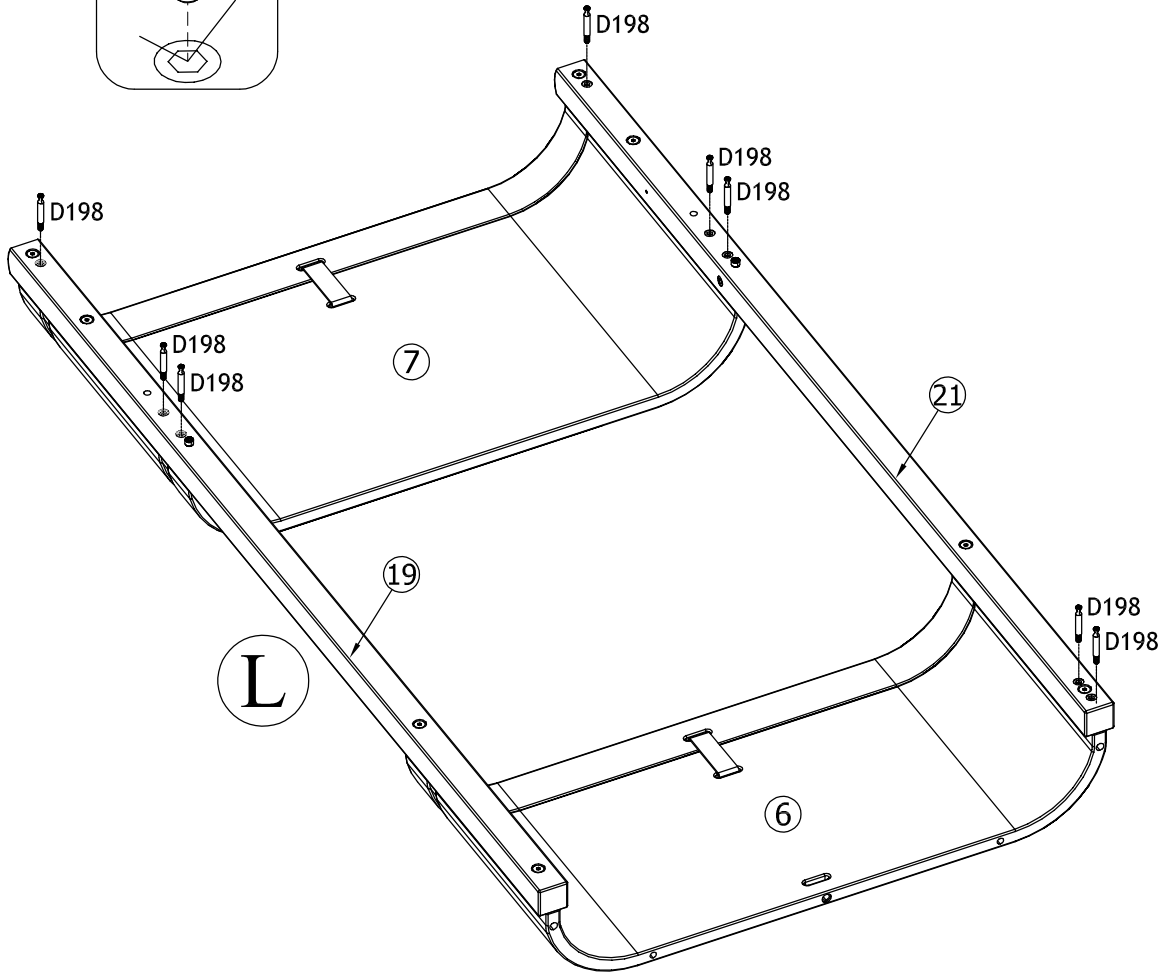
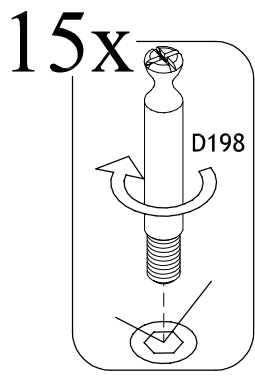
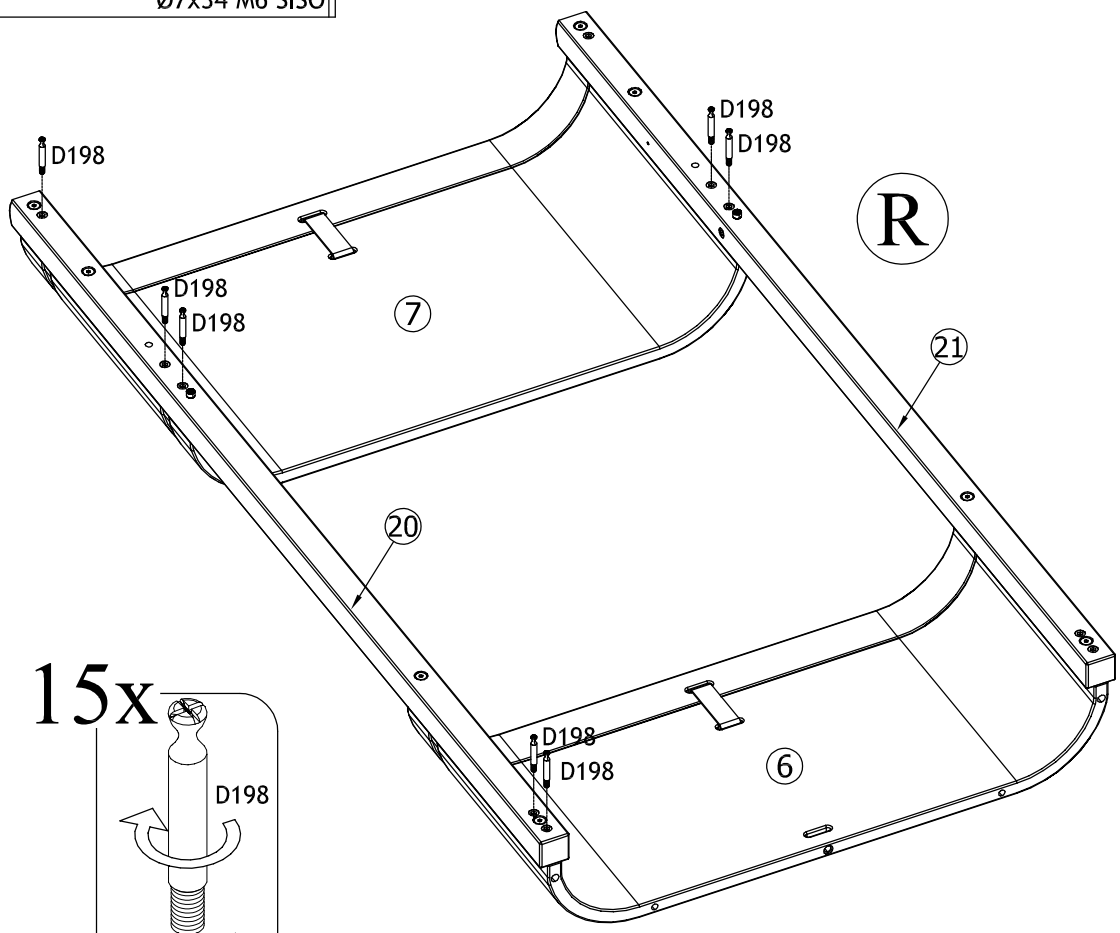

D198  x15
Ø7x34 M6 SISO

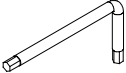

2.



D198		x15	D196		x15	D197		x15
								M10x7,5
A6		x1	H1		x4			
		4 mm			Ø8x30			

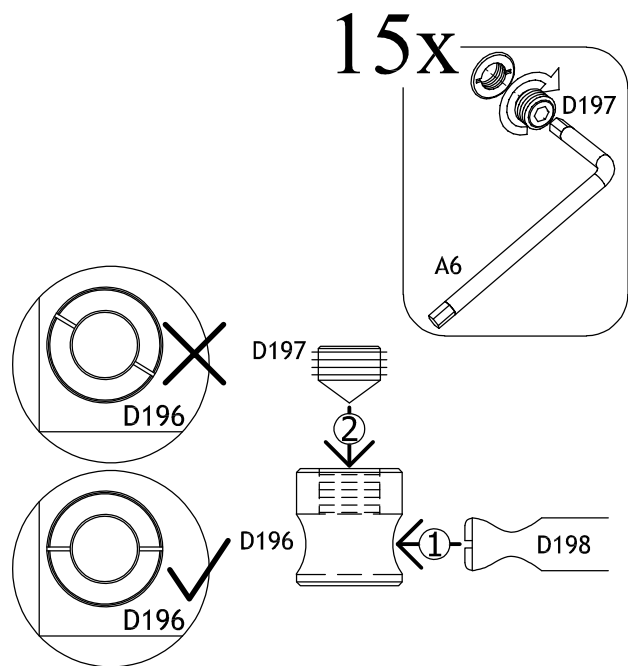
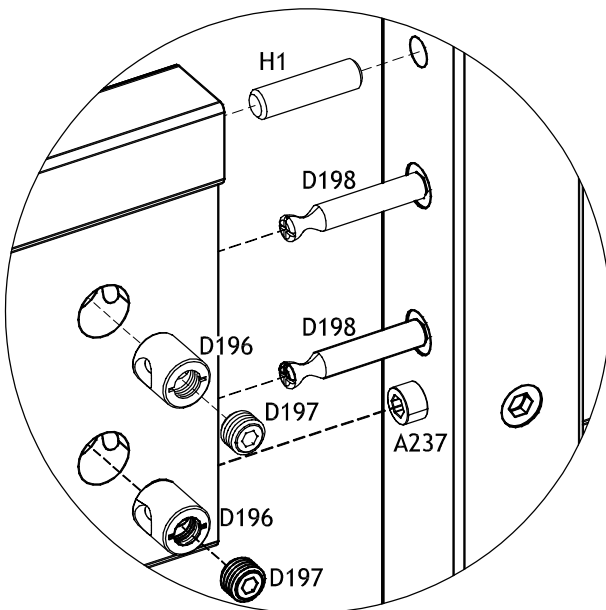
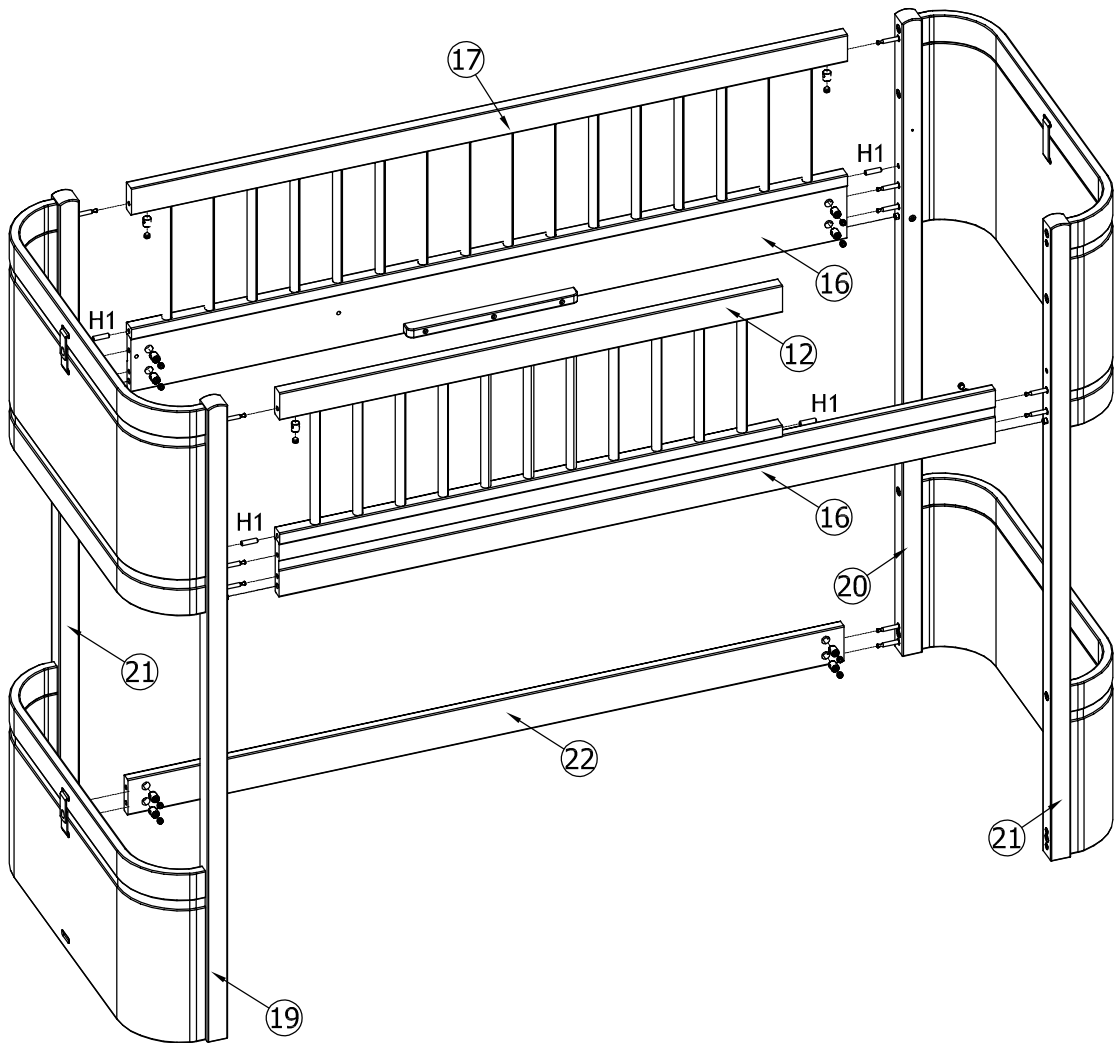

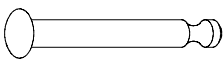
3.

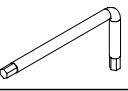
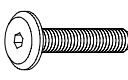
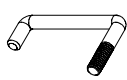
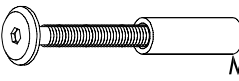

D223		x1 Ø7x60	D196		x1 Ø15x14	D197		x1 M10x7,5
A6		x1 4 mm	A83		x2 M6x35	D221		x2 M6
A236		x2 M6x60						

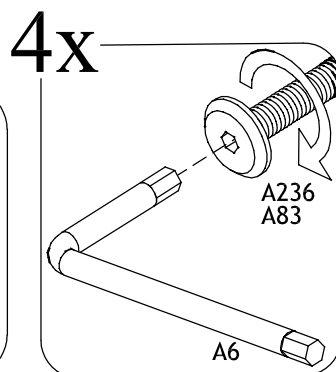
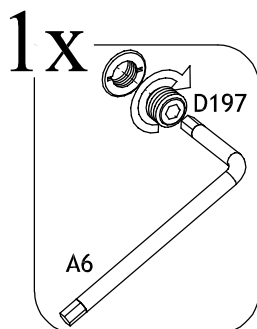
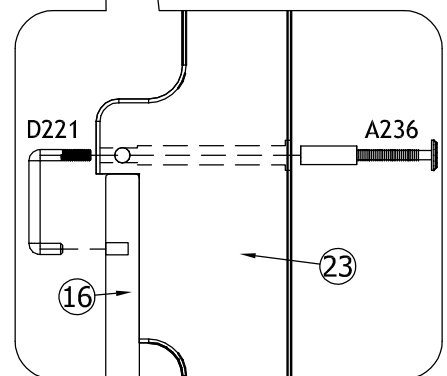
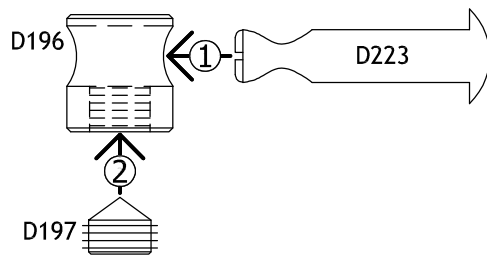
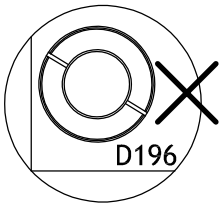
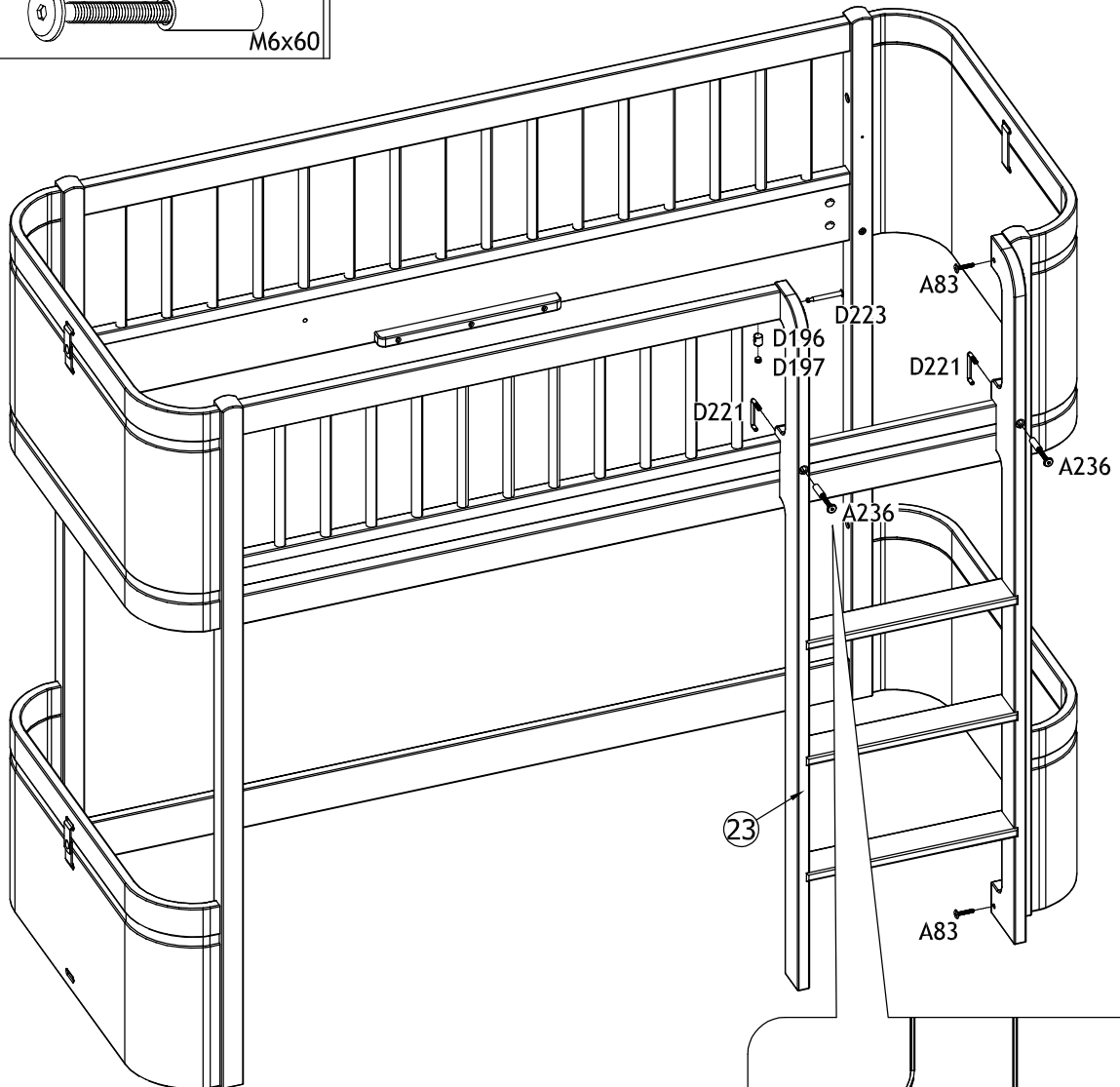
4.

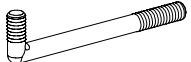

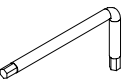
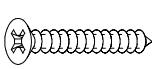
D169		x4	A103		x4	C18		x4
				M6/Ø15x12			Ø8,4/Ø15	
A6		x1	A66		x4			
	4 mm			Ø3,5x25				

5.

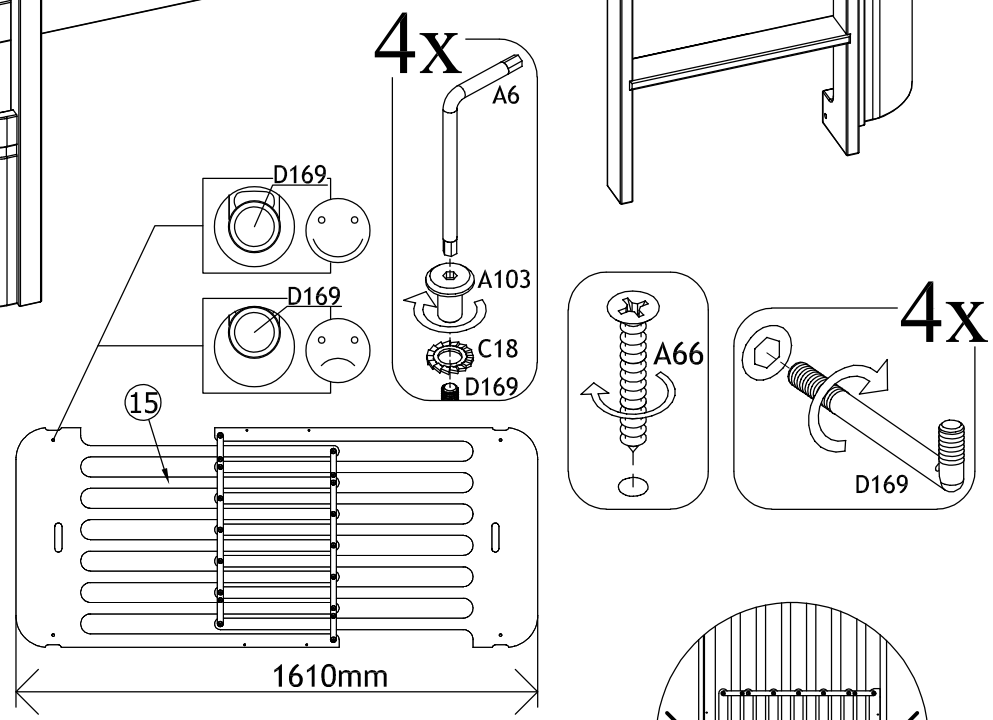
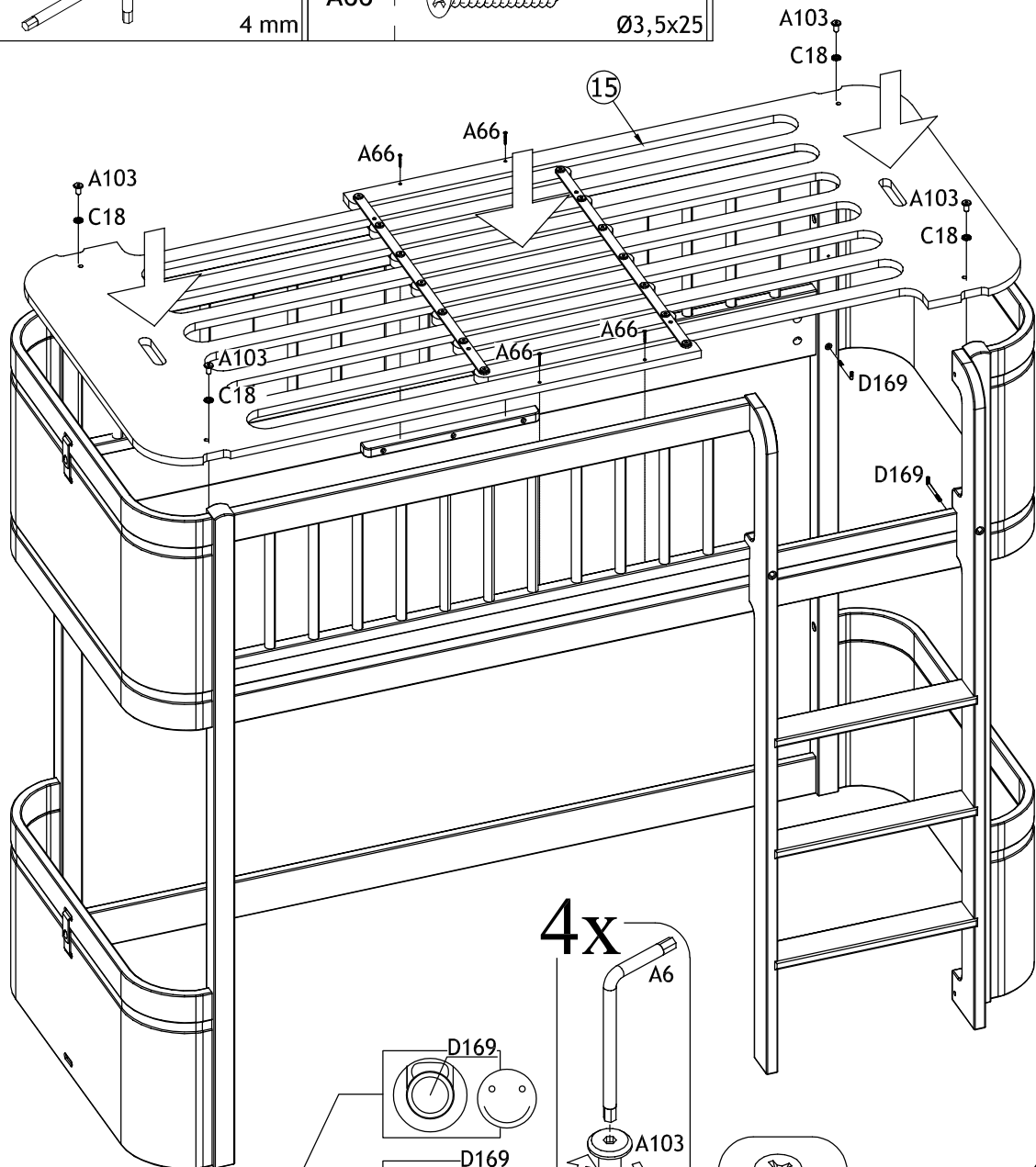

pres sengesiderne sammen
 press the bed sides together
 Bitte die Seitenteile unter
 Druck zusammenfügen

VIGTIG - GEM TIL SENERE BRUG: LÆS GRUNDIGT!

ADVARSLER:

1. **Advarsler:** højseng er ikke egnet til børn under 6 år grundet fare for ulykker ved fald.
2. **Advarsler:** efterlad eller placer ikke andre genstande i eller tæt ved højseng, som kan forårsage risiko for kvælning. F.eks. snore, liner, ledning m.m.
3. **Advarsler:** børn kan blive fastklemmt mellem højseng og væg. Sengen skal derfor placeres med en afstand til væggen på maximum 75 mm eller mere end 230 mm.
4. **Advarsler:** højseng bør ikke anvendes, såfremt dele på sengen er beskadigede, ødelagte eller helt mangler. Anvend kun reservedele som er godkendt af Oliver Furniture.
5. Tykkelsen på madrassen må ikke være mere end 150 mm. Vi anbefaler madrastykkelser imellem 100 - 150 mm. Se også markeringen på sengebenene.
6. Mål på madras skal være minimum 68 x 162 cm.
7. Toppen af madrassen skal være mindst 160 mm under den øverste kant af sikkerhedsgitteret. Se mærkning på sengestolpe.
8. Samlevejledning, beskrivelser og billeder af alle dele og værktøj skal altid medfølge før montering påbegyndes.
9. Alle beslag skal være fastspændte og disse bør tjekkes med jævne mellemrum og efterspændes.
10. Højeseng kan rengøres med en opvredet klud.
11. Det anbefales at udlufte værelset jævnligt for at forhindre forhøjet luftfugtighed og mug/skimmelsvamp ved og omkring sengen.
12. Disse sikkerhedsforskrifter er beskrevet i **DS/EN 747-1:2012 + A1:2015**.

**Oliver
furniture**

IMPORTANT - SAVE FOR LATER USE - READ CAREFULLY.

WARNINGS:

1. **Warning:** the loft bed is not suited for children under the age of 6 years due to danger of falling out of the loft bed.
2. **Warning:** never leave or place other objects in or close to the loft bed which may cause danger of suffocation. For example lines, strings, wires etc.
3. **Warning:** children can be wedged in between the loft bed and the wall. The loft bed must be placed with a distance to the wall of maximum 75 mm or more than 230 mm.
4. **Warning:** the loft bed must not be used if some parts on the loft bed are damaged or missing. Only use spare parts approved by Oliver Furniture.
5. The thickness of the mattress cannot exceed 150 mm. We recommend mattress thickness between 100 - 150 mm. Please also see mattress marking on the legs of the bed.
6. Dimension of the mattress must be in minimum 68 x 162 cm.
7. The top of the mattress shall be at least 160 mm below the upper edge of the safety barriers. Please note the marking on the bed post.
8. Assembly instruction, descriptions and pictures of all parts of the loft bed and tools must be included before assembly can take place.
9. All fittings must be tightened, checked regularly and re - tightened.
10. The loft bed can be cleaned with a wrung cloth.
11. It is recommended to ventilate the room in order to keep the humidity low and prevent mould in and around the loft bed.
12. All safety regulations are described in **DS/EN 747-1:2012 + A1:2015.**

**Oliver
furniture**

WICHTIG - BEWAHREN SIE DIE ANLEITUNG FÜR SPÄTER AUF - GRÜNDLICH DURCHLESEN!

ACHTUNG:

1. **Achtung:** das Halbhochbett ist nicht geeignet für Kinder unter 6 Jahre auf Grund der Sturzgefahr.
2. **Achtung:** hinterlassen Sie keine Gegenstände im oder in der Nähe des Bettes, die zu einem Erstickungsrisiko führen könnten, z.B. Schnüre, Bänder, oder ähnliches.
3. **Achtung:** Kinder können zwischen dem Halbhochbett und der Wand festgeklemmt werden. Das Halbhochbett sollte daher mit einem Abstand zur Wand auf Maximum 75 mm oder mehr als 230 mm platziert werden.
4. **Achtung:** das Halbhochbett sollte nicht verwendet werden in dem Fall, dass Teile fehlen, oder am Bett etwas beschädigt oder kaputt ist. Nur Ersatzteile verwenden, die von Oliver Furniture überprüft und bestätigt wurden.
5. Die Dicke der Matratze sollte nicht mehr sein als 150 mm. Wir empfehlen, daß die Matratze zwischen 100 - 150 mm dick ist. Sehen Sie auch die Markierung für die maximale Matratzenhöhe am Bettpfosten.
6. Die Maße der Matratze sollten Minimum 68 x 162 cm groß sein.
7. Die Oberseite der Matratze muss mindestens 160 mm unterhalb der Oberkante der Sicherheitsbarriere sein. Siehe Markierung auf die Bettpfoste.
8. Die Montageanleitung, Beschreibungen und Bilder von allen Teilen und Werkzeug sollten vorhanden sein ehe mit der Montage angefangen wird.
9. Alle Scharniere müssen festgespannt sein, und sollten regelmäßig überprüft und nachgespannt werden.
10. Das Halbhochbett lässt sich mit einem feuchten Tuch sauber machen.
11. Es wird empfohlen, den Raum regelmäßig zu lüften um hoher Feuchtigkeit zu verhindern - damit Schimmelbildung in und um das Halbhochbett zu vermeiden.
12. Diese Sicherheitsvorschriften sind im **DS/EN 747-1:2012 + A1:2015** beschrieben.

**Oliver
furniture**

Conversion Possibilities Umbau Möglichkeiten Ombygningsmuligheder

Tremmeseng/Juniorseng
Cot/Junior bed
Babybett/Juniorbett

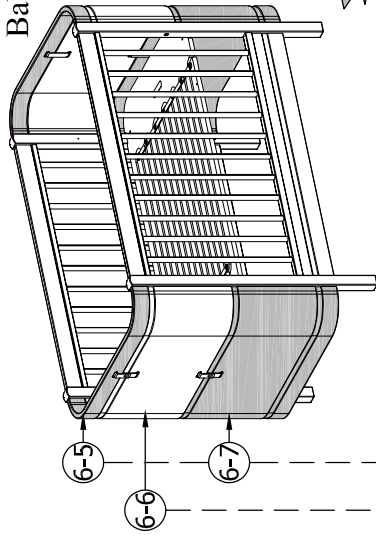



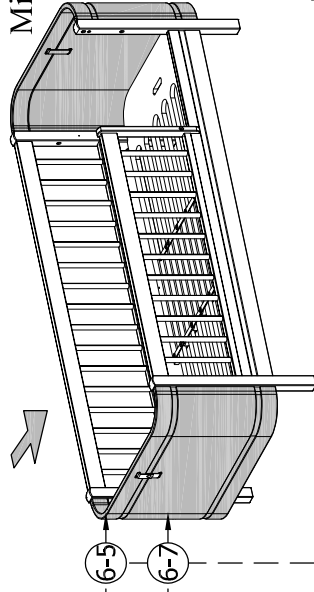

Mini+ Juniorseng
Mini+ Junior bed
Mini+ Juniorbett

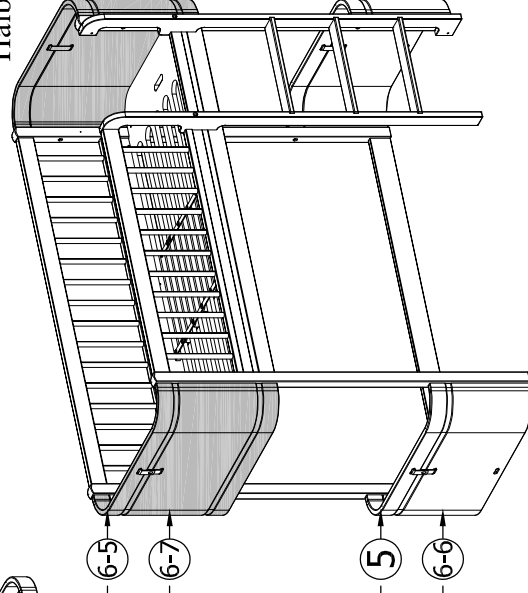
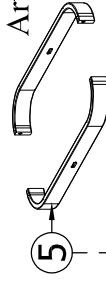

Halvhøj seng
Low loft bed
Halbhohes Hochbett

Art. 051451

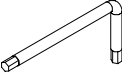

D198	 x2 Ø7x34 M6 SISO	H2	 x8 Ø8x40	D197	 x2 M10x7,5
D196	 x2 Ø15x14	A6	 x1 4 mm		

