

MESH

design Francisco Gomez Paz

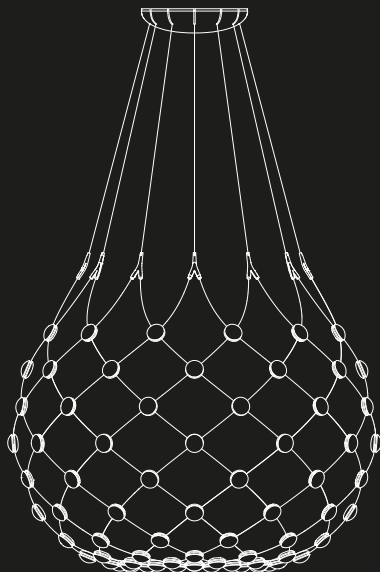

**LUCE
PLAN**

D86/T1..T5/1..8
D86/N - D86/NPI



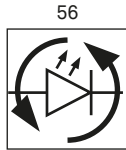
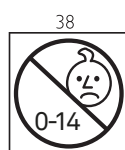
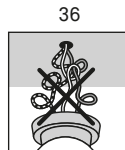
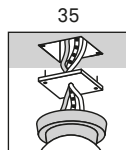
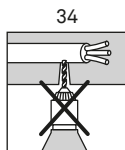
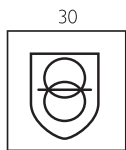
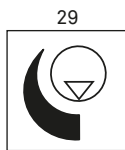
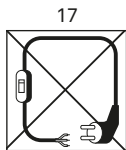
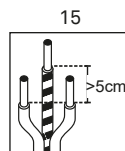
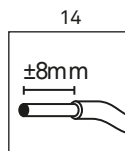
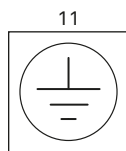
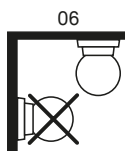
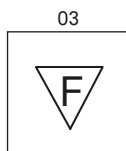
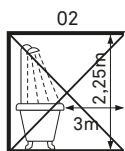
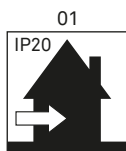

D86/T1/1

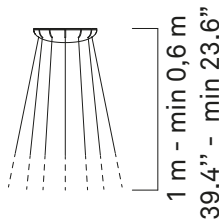

kg 1,5kg **lb** 3,3 lb

D86/T5/1

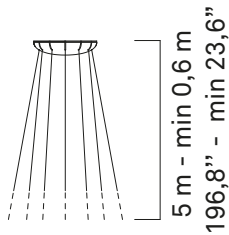

kg 1,7kg **lb** 3,75 lb



D86N

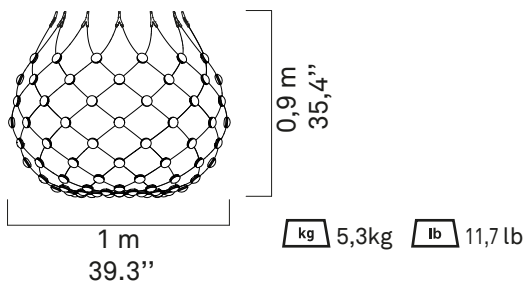

D86/T1/8

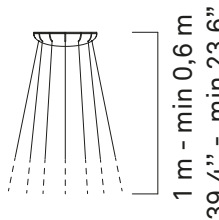

kg 1,2kg **lb** 2,65 lb

D86/T5/8

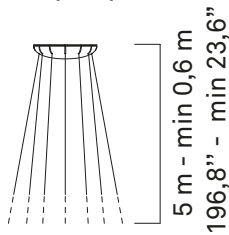

kg 1,4kg **lb** 3,1 lb



D86NPI

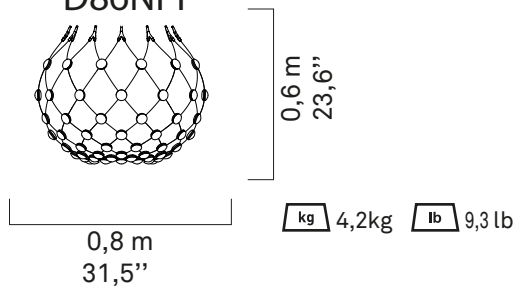

D86/T1/1

D86/T5/1

D86/T1/8

D86/T5/8

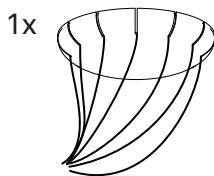

D86/N

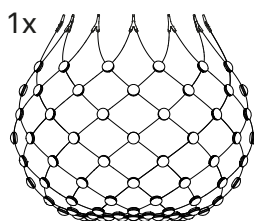

D86/NPI

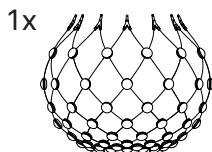

1

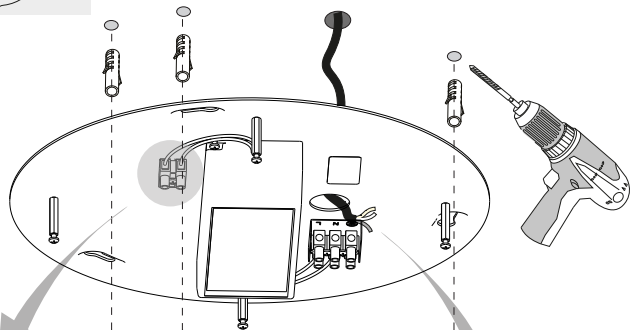
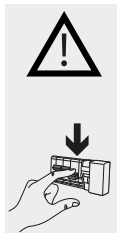

1.1

1.2

Click!

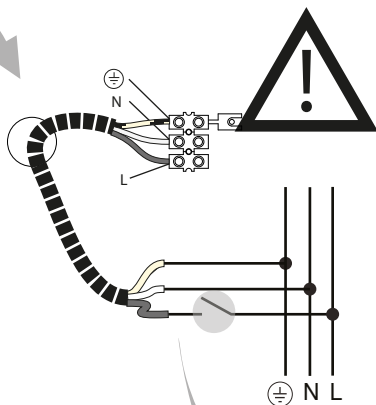
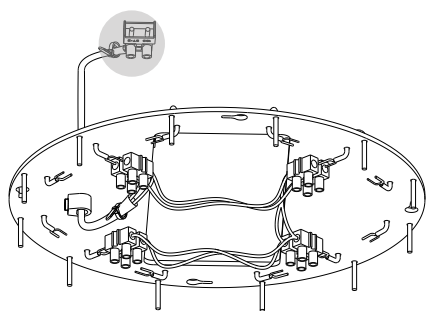

29



(0,1%)   MAX (100%)

2

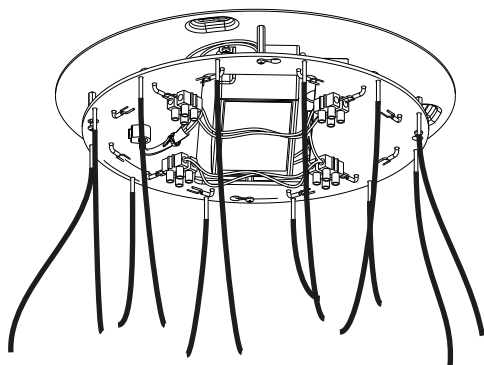
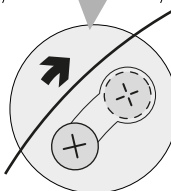
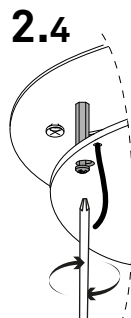
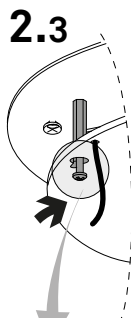
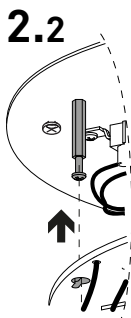
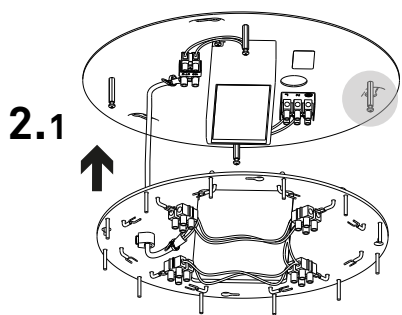

3

D86/T1/1 | D86N
D86/T5/1 |
D86/T1/8 | D86NPI
D86/T5/8 |

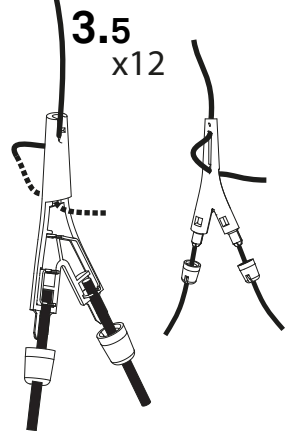
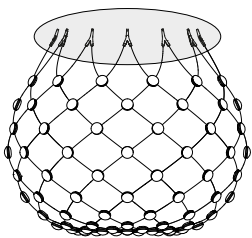
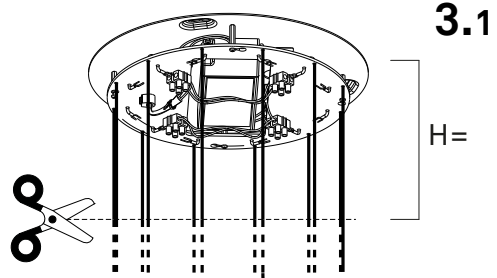

3.2

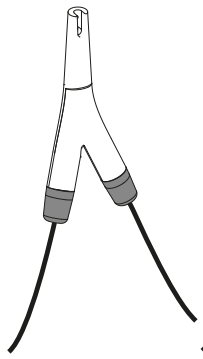

3.3 x12

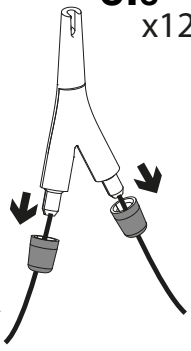

3.4 x12

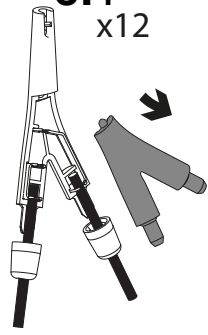

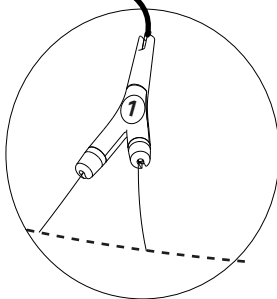
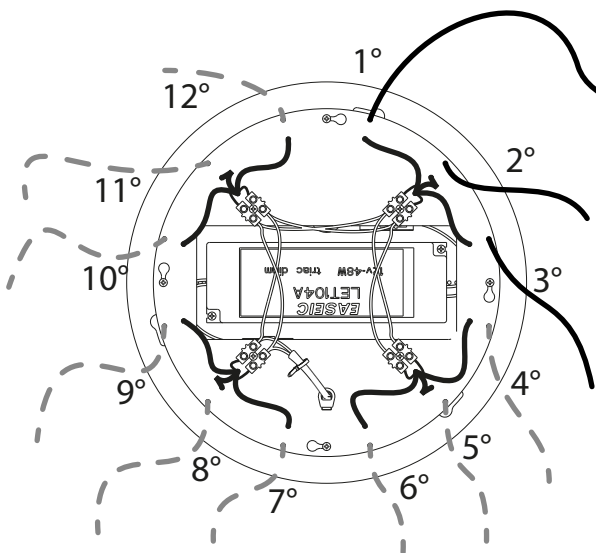

3.6

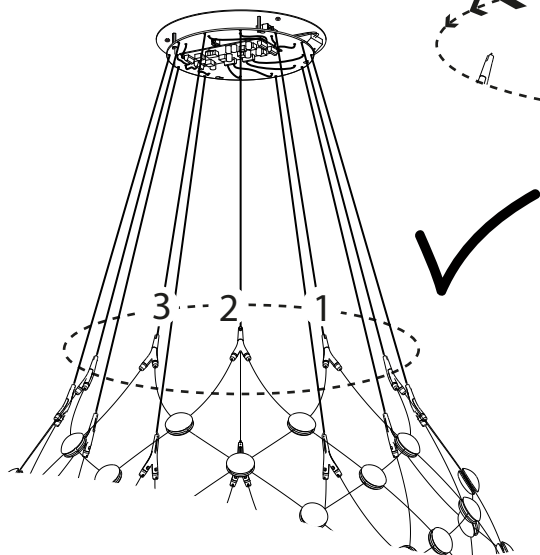
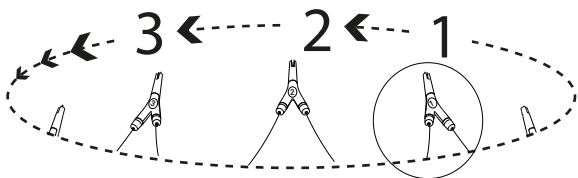

4

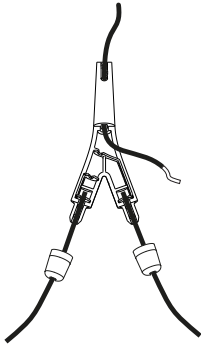

4.1
x12

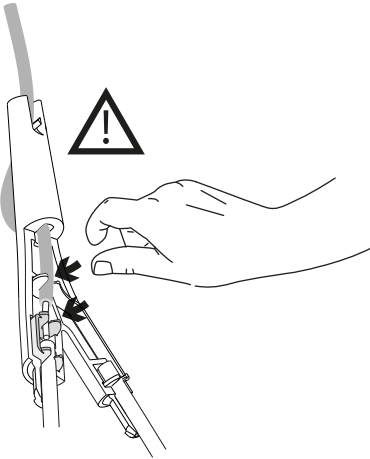
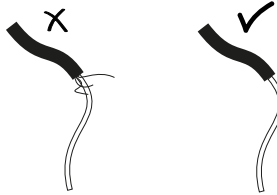
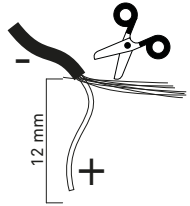

4.2
x12

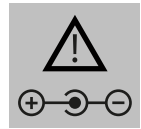
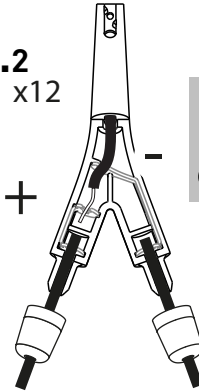

4.3
x12

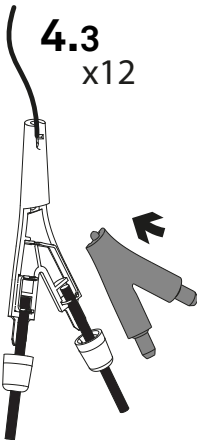

4.4
x12

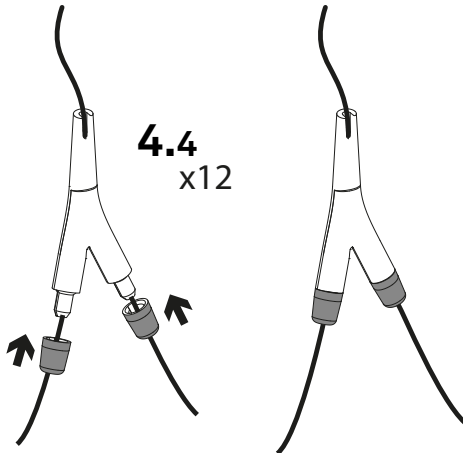

5

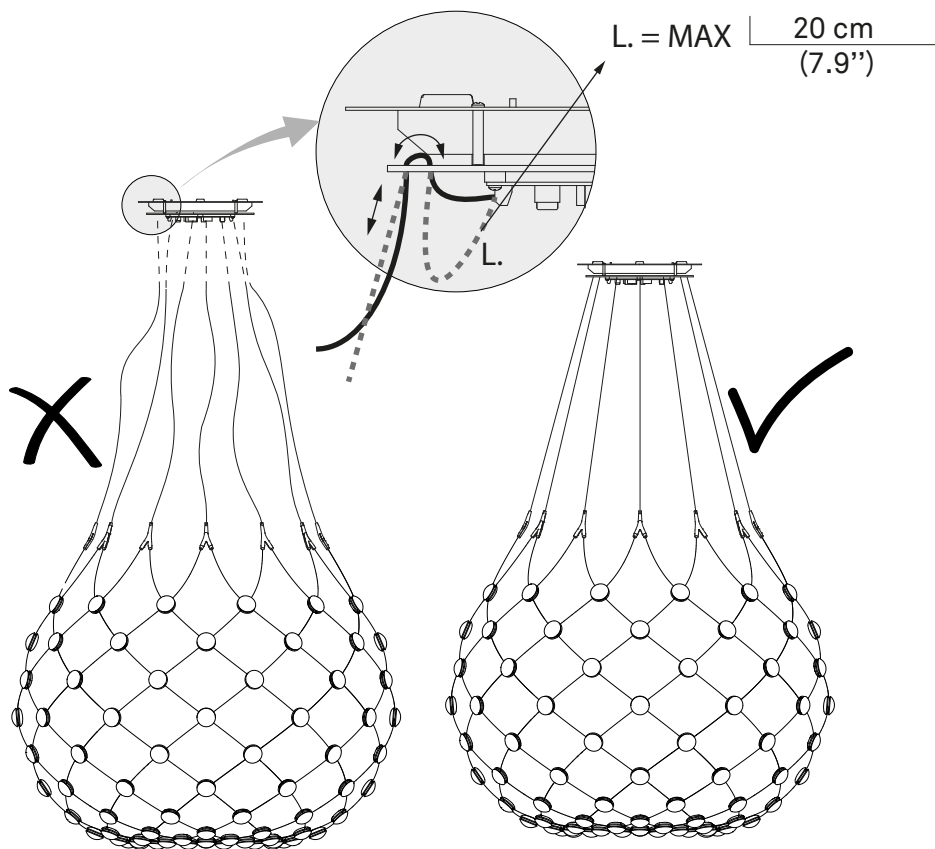

6

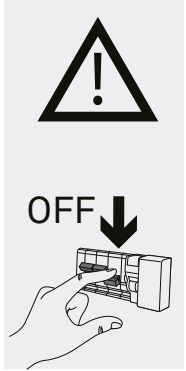
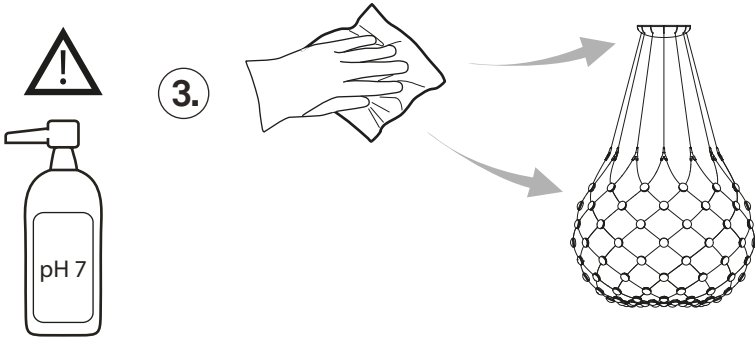
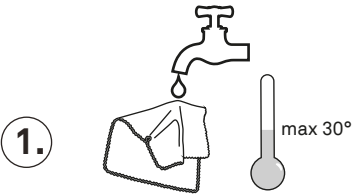
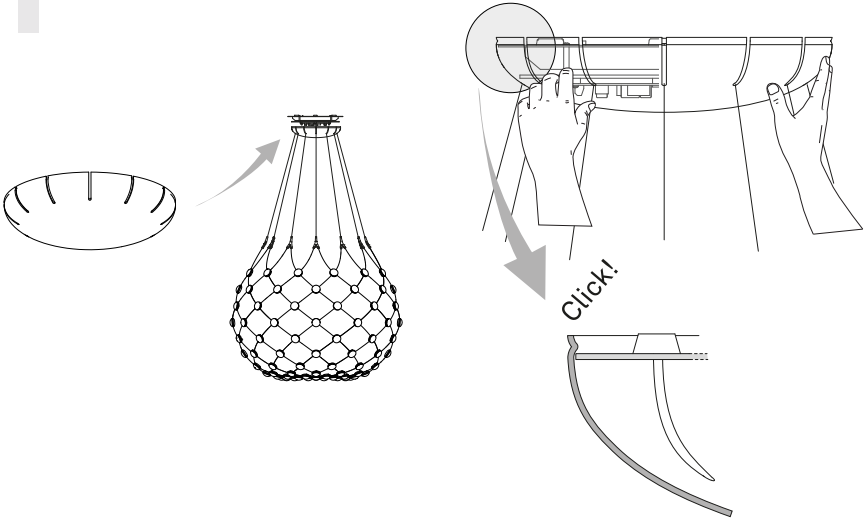



www.luceplan.com

D86010007